



**INDALSU**

**domo**

**125**

**sistema corredera**



# domo

# 125

sistema corredera

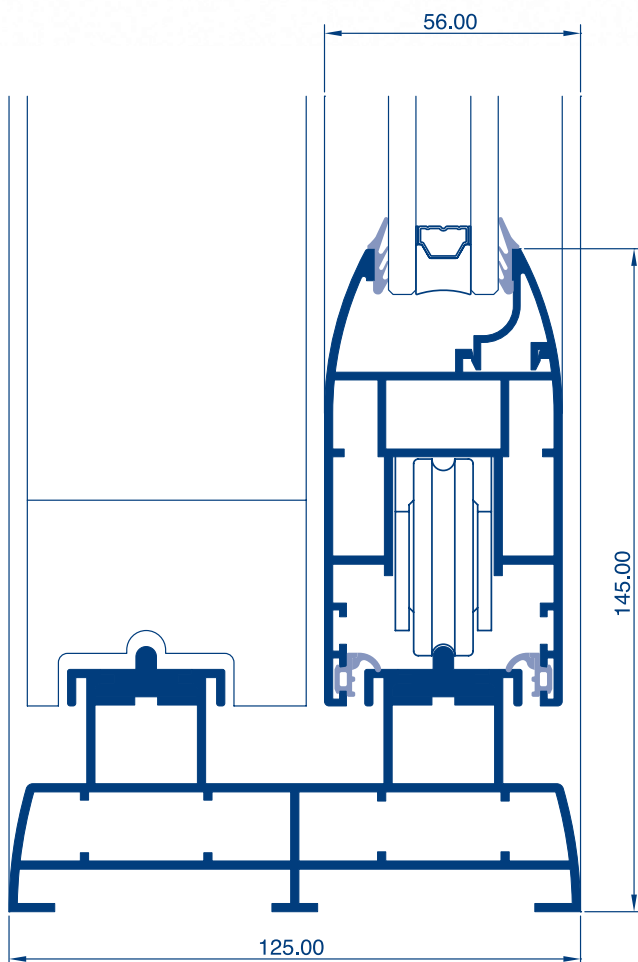

## CARACTERÍSTICAS

Tipo corredera elevable o en línea.

Corte a inglete.

Perfilería de extrusión en aleación 6063.

Espesor general 1.8 mm.

Acrilamiento por medio de juntas en EPDM.

Escuadras de unión en aluminio inyectado con pulsante de anclaje.

Escuadras de alineación en acero inox.

Perfil de rodadura con posibilidad de renovación.

Anchura de marco 125 mm.

Anchura de hoja 52 mm.

Rodamientos para 250 kg en línea y 300 kg en elevable y 400 kg en elevable con suplementos.



EN 14351-1  
LGAI Technological Center, S.A  
(APPLUS) Organismo Notificado N°0370

Sistema DOMO 125. Consultar especificaciones de cálculo.

Resistencia a la carga de viento	Clase C4
Permeabilidad al aire	Clase 3
Estanqueidad al agua	7A
Sustancias peligrosas	NPD
Capacidad de soporte de carga de los dispositivos de seguridad	APTO
Prestaciones acústicas	29dB
Transmitancia térmica (Uw)	desde 3,8 W/m <sup>2</sup> K

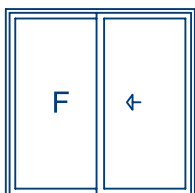

Corredera con fijo

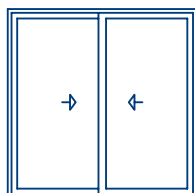

Corredera de 2 hojas

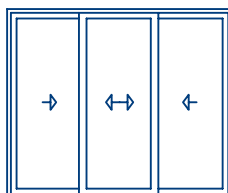

Corredera de 3 hojas

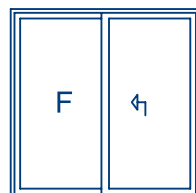

Corredera Elevable con fijo

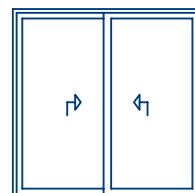

Corredera Elevable de 2 hojas

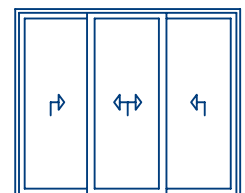

Corredera Elevable de 3 hojas en 2 carriles



Referencia	Sección	Designación	Peso g / ml	Perímetro dm2 / ml	Inercia Ix cm4	Inercia Iy cm4
2600		Marco perimetral	2681	108.4	25.4396	140.5563
2602		Hoja perimetral	1950	80.5	28.0000	41.9734
2603		Junquillo clip	262	12.3		
2604		Cruce de hojas	913	38.3	12.5025	11.8605
2605		Tapacanal	86	12.0		
2606		Guia rodadura	302	12.0		
2608		Suplemento cierre	421	18.5		
2609		Junquillo grapa	184	12.0		
2610		Divisor hoja	1269	54.7	11.9751	26.9810
2801		Junquillo curvo 11.5	254	15.0		
2802		Junquillo curvo 14	227	14.9		
2803		Junquillo curvo 17.5	233	15.4		
2804		Junquillo curvo 22.5	267	17.4		
2805		Junquillo curvo 29	286	18.8		
2806		Junquillo recto 11.5	236	15.4		
2807		Junquillo recto 14	239	15.6		
2808		Junquillo recto 17.5	246	16.1		
2809		Junquillo recto 22.5	261	17.0		
2810		Junquillo recto 29	293	19.0		
2811		Junquillo grapa 11.5	192	10.9		
2812		Junquillo recto 35	316	20.5		
2813		Junquillo curvo 35	340	19.9		
2814		Pletina cremona	157	4.71		
2819		Junquillo grapa 17.5	214	12.0		

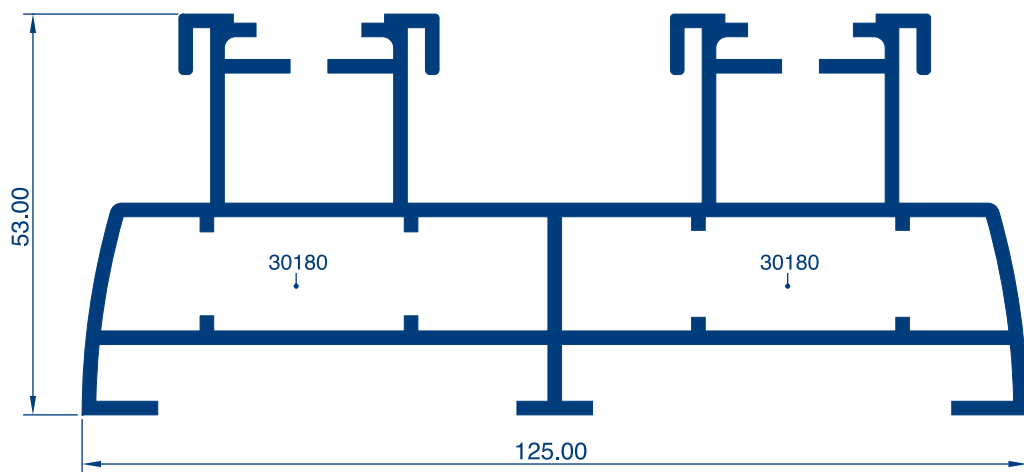
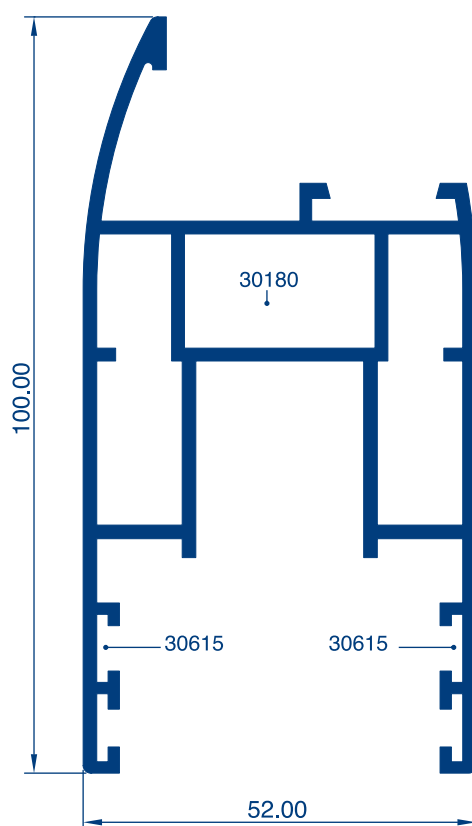

Referencia	Sección	Designación	Peso g / ml	Perímetro dm2 / ml	Inercia Ix cm4	Inercia Iy cm4
2820	⌒	Junquillo grapa 22.5	232	13.1		
2821	⌒	Junquillo grapa 14	203	11.4		
2822	⌒	Junquillo grapa 29	254	14.0		
2823	⌒	Junquillo grapa 35	273	15.2		
2824	⌒	Junquillo curvo 25.7	278	18.0		
2825	⌒	Junquillo grapa 25.7	226	13.6		
2826	⌒	Junquillo recto 9.0	189	10.7		
2827	⌒	Junquillo recto 38	326	21.1		
2882	⌒	Junquillo recto 20	261	17.0		
3412	⌒	Vierteaguas	200	12.0		

**Ref. 2600****Ref. 2602**



**Ref. 2605**

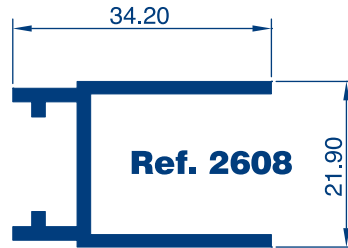

**Ref. 2608**

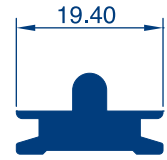

**Ref. 2606**

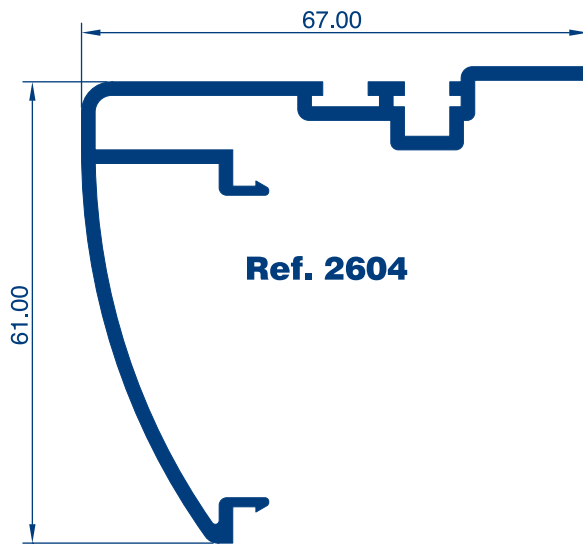

**Ref. 2604**

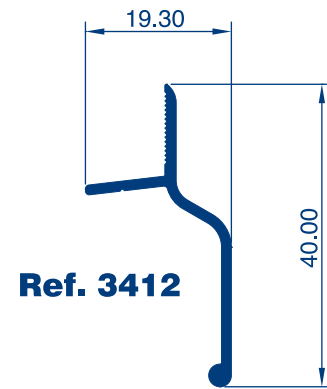

**Ref. 3412**

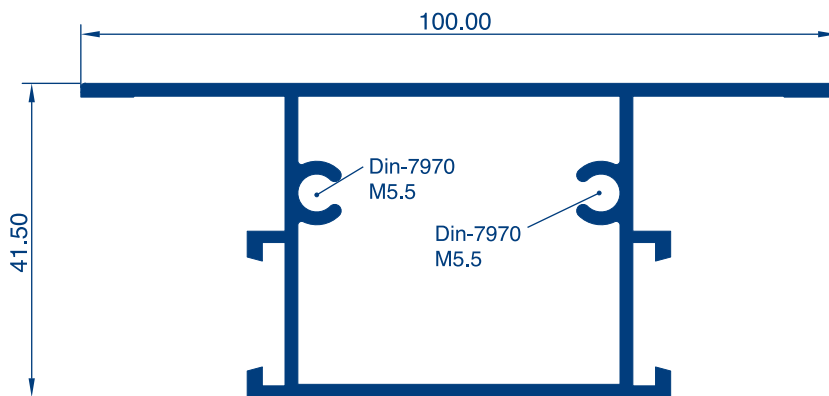

**Ref. 2610**

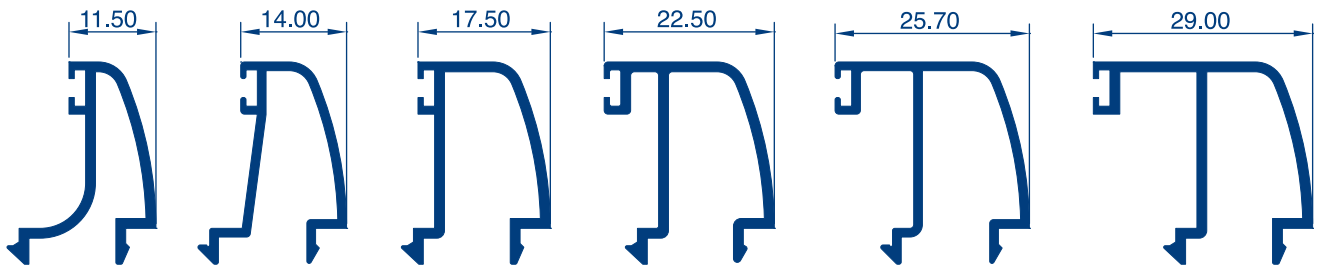
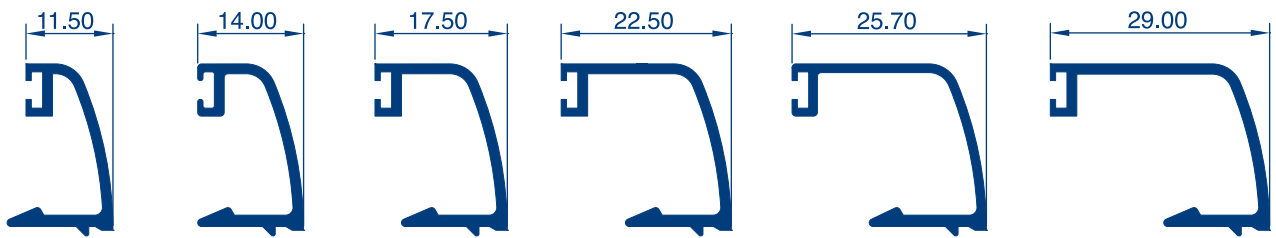
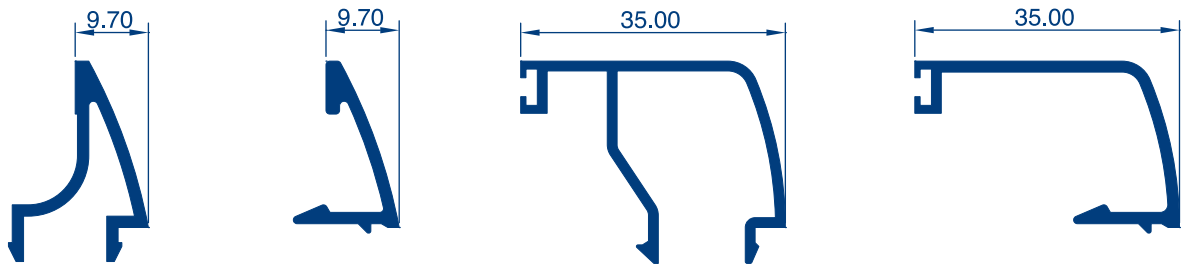
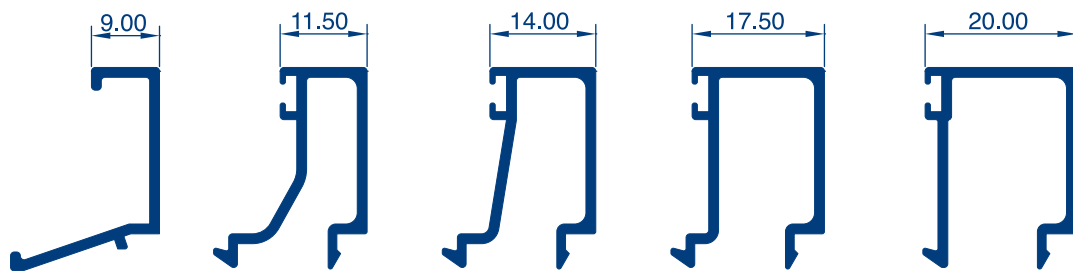
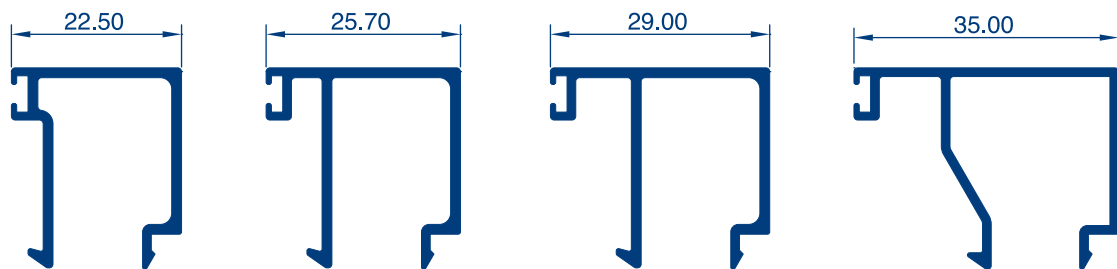

**Ref. 2814**

**2801****2802****2803****2804****2824****2805****2811****2821****2819****2820****2825****2822****2603****2609****2813****2823****2826****2806****2807****2808****2882****2809****2883****2810****2812**



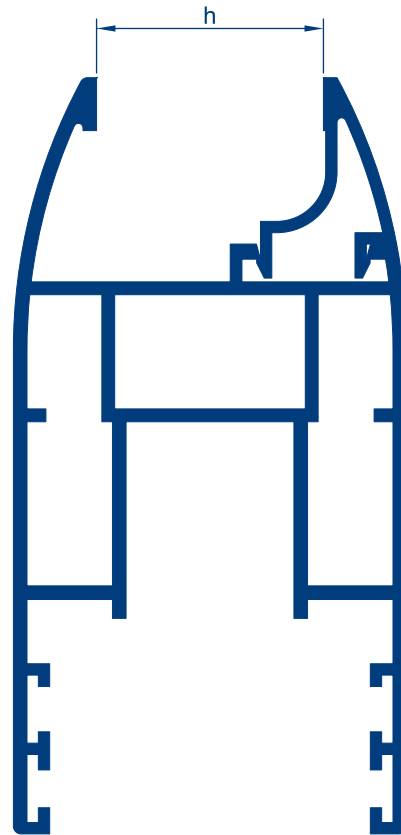

### HUECOS LIBRES PARA ACRISTALAR

Hueco en hoja 2602		
Referencia	Referencia	Hueco (h)
2603 (9.7mm)	2609	30.00 mm
2801 (11.5mm)	2811	28.00 mm
2802 (14.0mm)	2821	26.00 mm
2803 (17.5mm)	2819	22.50 mm
2804 (22.5mm)	2820	17.50 mm
2824 (25.7mm)	2825	14.00 mm
2805 (29.0mm)	2822	11.00 mm
2813 (35.0mm)	2823	5.00 mm



## Ventana 2 hojas elevable

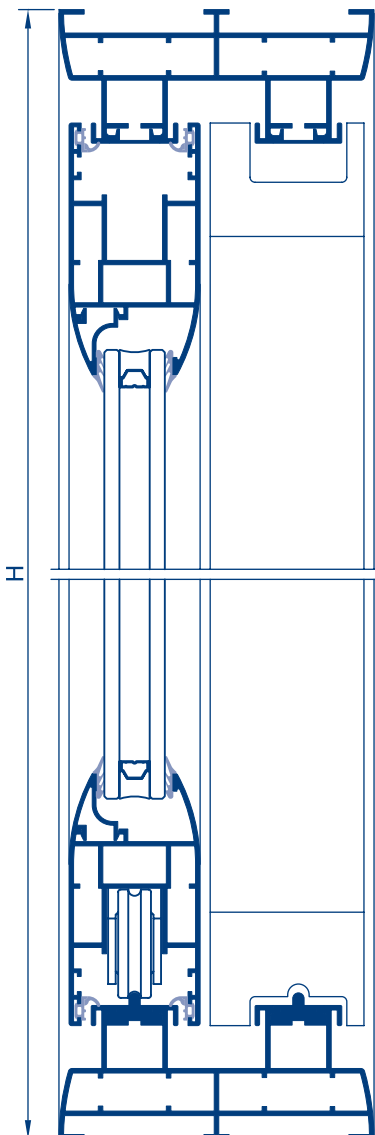
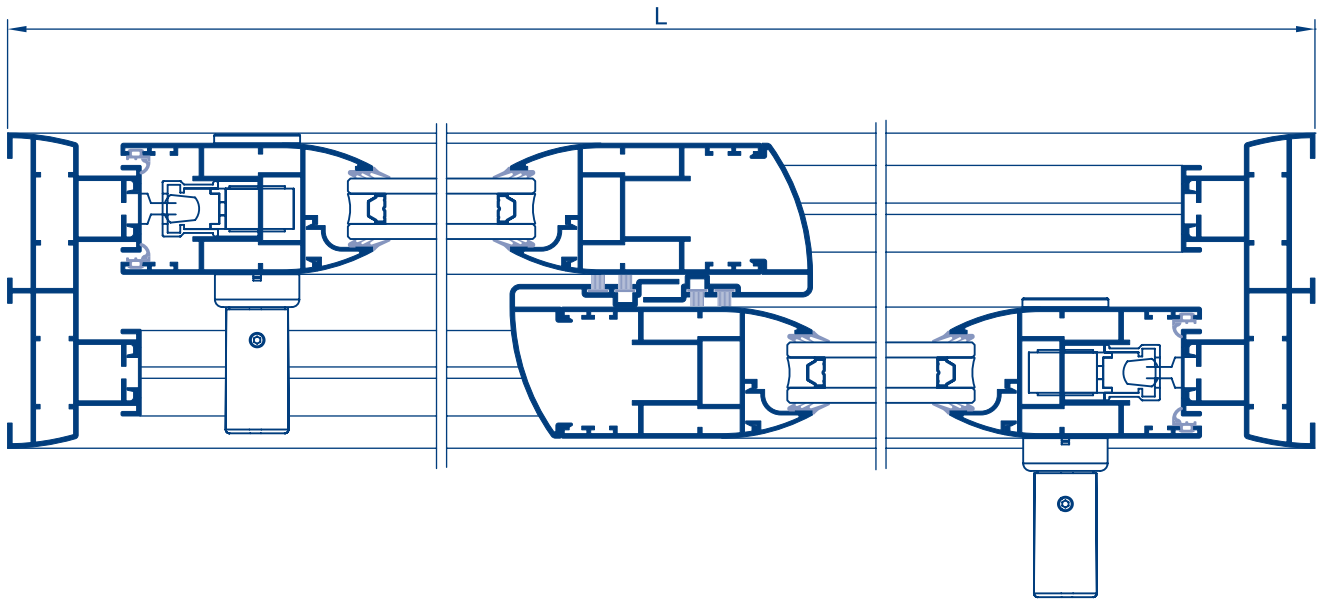

	Ref.	Descripción	Horizontal			Vertical		
			Corte	Cantidad	Medida	Corte	Cantidad	Medida
	2600	Marco perimetral		2	L		2	H
	2602	Hoja perimetral		4	L/2 - 5		4	H - 90
	2604	Cruce de hojas					2	H - 180
	2603	Junquillo clip					4	H - 237
	2609	Junquillo grapa		4	L/2 - 161			
	2605	Tapa marco		2	L		4	H
	2606	Guia de rodamiento		2	L			

Ref.	Descripción	Horizontal		Vertical	
		Cantidad	Medida	Cantidad	Medida
31061	Junta elevable	8	L / 2	4	H
30710	Cepillo (7x9)			4	H

Ref.	Descripción	Cant.
30180	Escuadra ventana	16
30615	Escuadra alineamiento hoja	16
30465	Juego tapas cruce de hojas	2
30124	Cortavientos inferior	1
30125	Cortavientos superior	1
	Kit corredera elevable	2
30375	Tapa salida de aguas	4

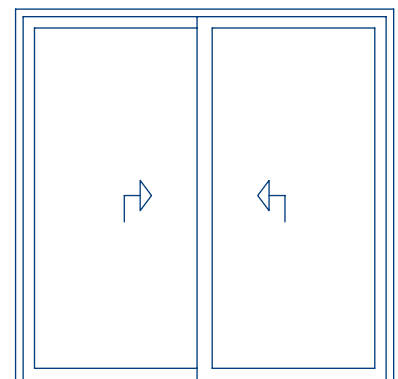



## Ventana 2 hojas en línea

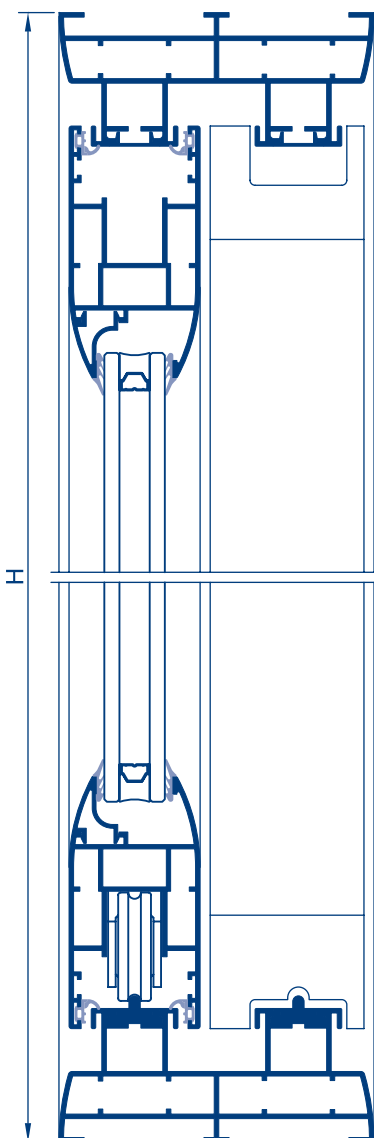
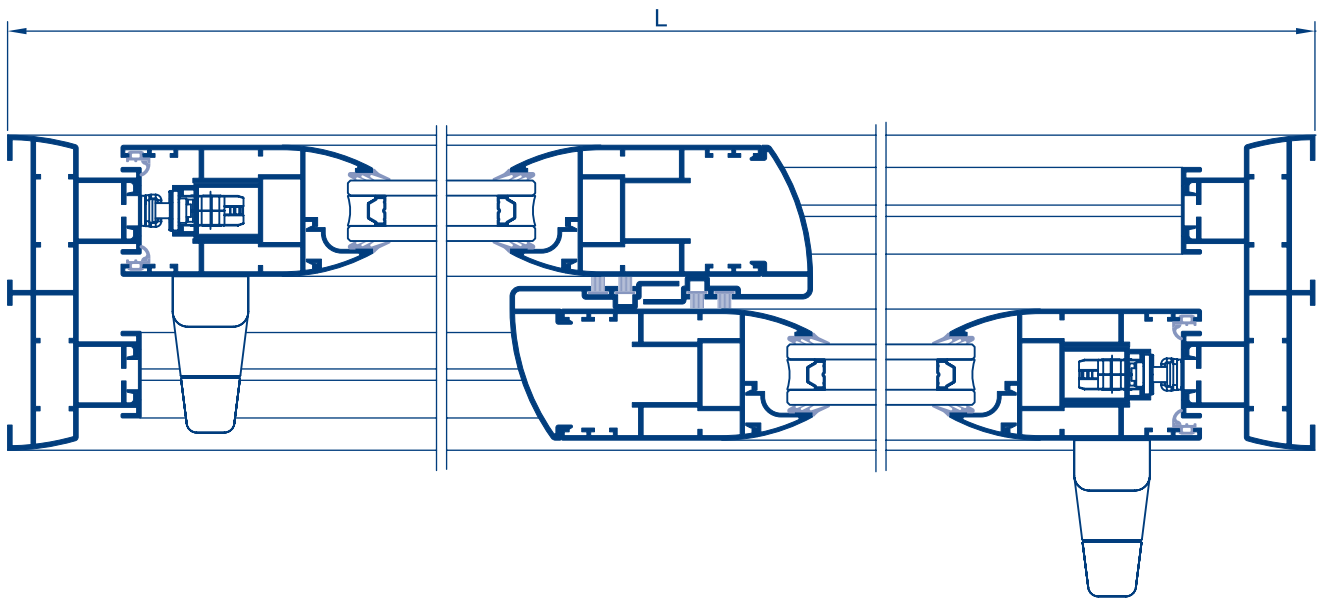

	Ref.	Descripción	Horizontal			Vertical		
			Corte	Cantidad	Medida	Corte	Cantidad	Medida
	2600	Marco perimetral		2	L		2	H
	2602	Hoja perimetral		4	L/2 - 5		4	H - 90
	2604	Cruce de hojas					2	H - 180
	2608	Suplemento cierre					1	H - 200
	2603	Junquillo clip					4	H - 237
	2609	Junquillo grapa		4	L/2 - 161			
	2605	Tapa marco		2	L		4	H
	2606	Guía de rodamiento		2	L			

Ref.	Descripción	Horizontal		Vertical	
		Cantidad	Medida	Cantidad	Medida
31061	Junta elevable	8	L / 2	4	H
30710	Cepillo (7x9)			4	H

Ref.	Descripción	Cant.
30180	Escuadra ventana	16
30615	Escuadra alineamiento hoja	16
30465	Juego tapas cruce de hojas	2
30124	Cortavientos inf. /sup.	2
	Kit corredera en línea	2
30375	Tapa salida de aguas	4

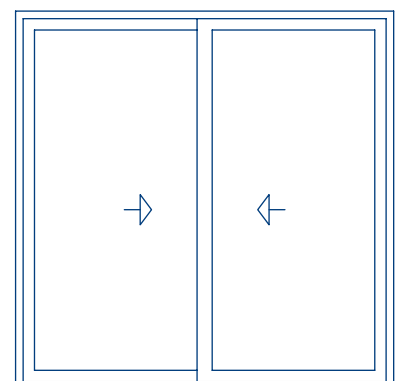



## Ventana 3 hojas iguales elevable (Apertura 1/3)

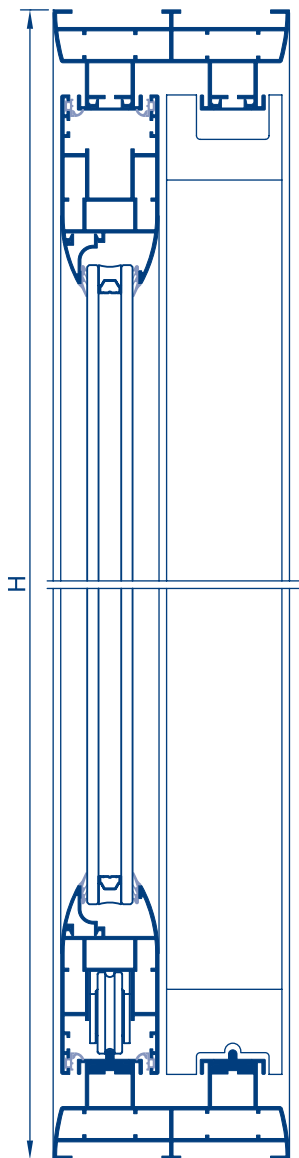
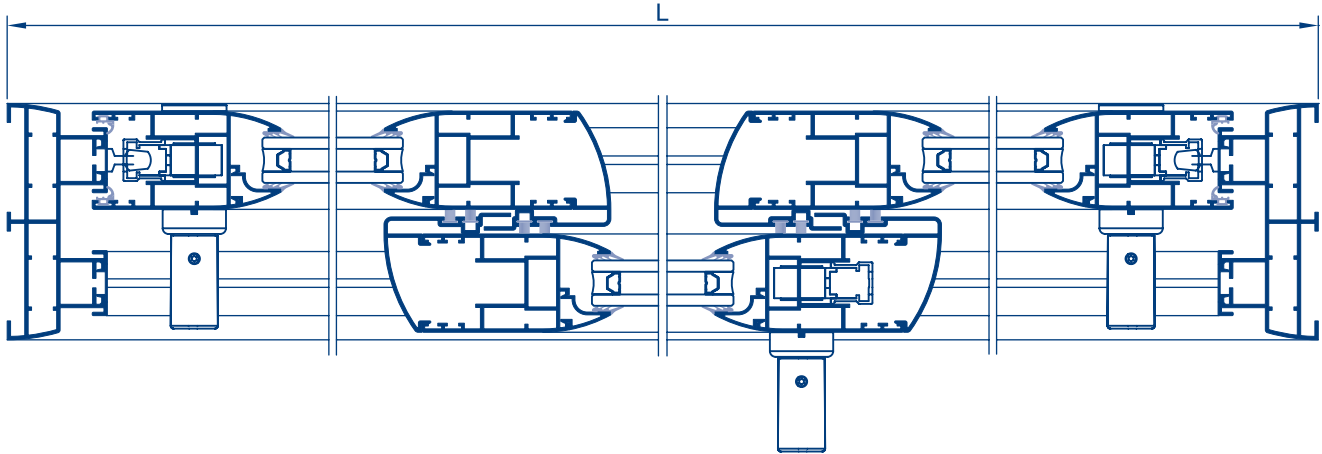

	Ref.	Descripción	Horizontal			Vertical		
			Corte	Cantidad	Medida	Corte	Cantidad	Medida
	2600	Marco perimetral		2	L		2	H
	2602	Hoja perimetral		4 2	L/3 - 23 L/3 + 23		6	H - 90
	2604	Cruce de hojas					4	H - 180
	2603	Junquillo clip					6	H - 237
	2609	Junquillo grapa		4	L/2 - 161			
	2605	Tapa marco		2	L		4	H
	2606	Guia de rodamiento		2	L			

Ref.	Descripción	Horizontal		Vertical	
		Cantidad	Medida	Cantidad	Medida
31061	Junta elevable	8	L / 2	4	H
30710	Cepillo (7x9)			4	H

Ref.	Descripción	Cant.
30180	Escuadra ventana	16
30615	Escuadra alineamiento hoja	16
30465	Juego tapas cruce de hojas	2
30124	Cortavientos inferior	1
30125	Cortavientos superior	1
	Kit corredera elevable	2
30375	Tapa salida de aguas	4

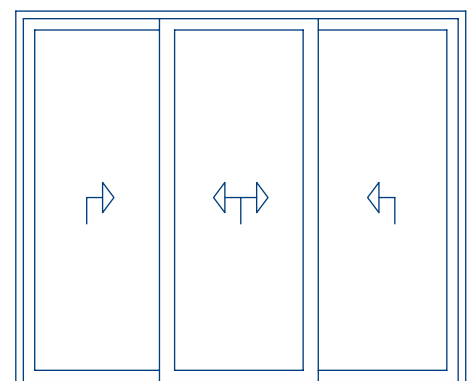



## Ventana 3 hojas desiguales elevable (Apertura 1/2)

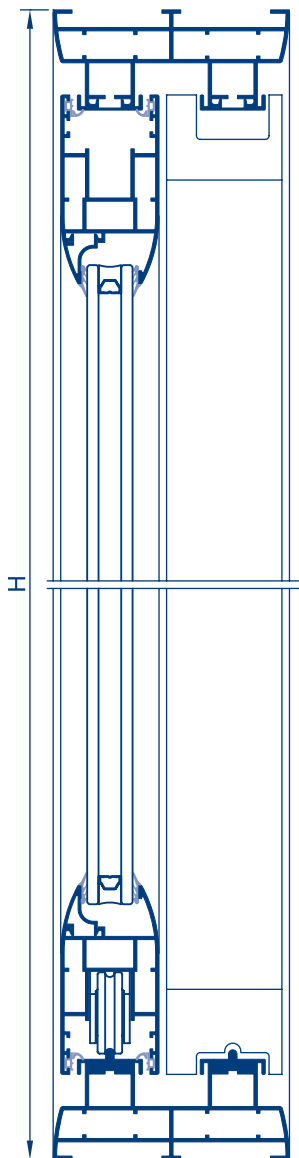
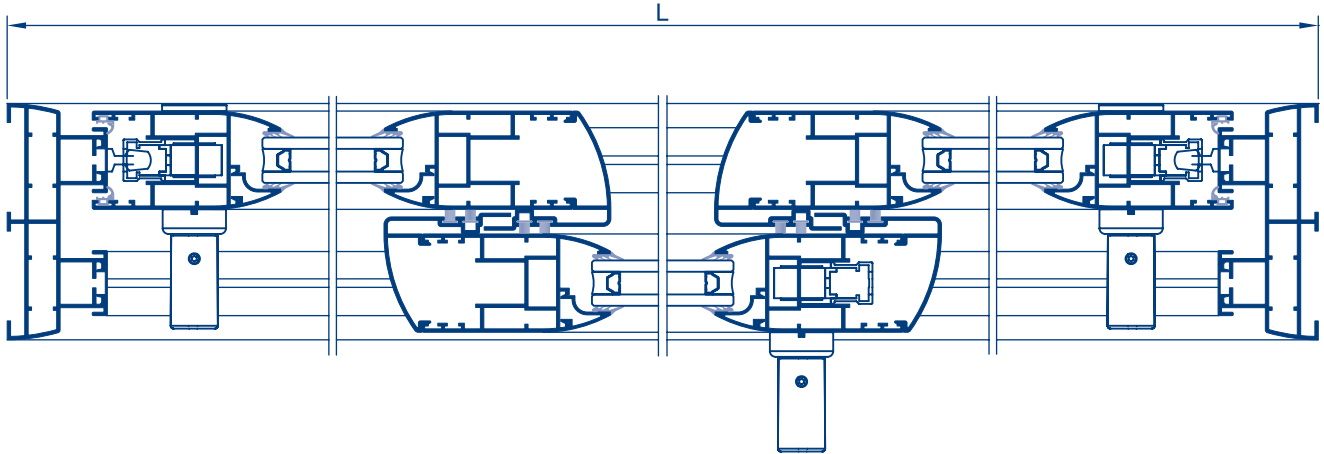

	Ref.	Descripción	Horizontal			Vertical		
			Corte	Cantidad	Medida	Corte	Cantidad	Medida
	2600	Marco perimetral		2	L		2	H
	2602	Hoja perimetral		4 2	L/4 + 56 L/2 - 43		4	H - 90
	2604	Cruce de hojas					4	H - 180
	2603	Junquillo clip					4	H - 237
	2609	Junquillo grapa		4	L/2 - 161			
	2605	Tapa marco		2	L		4	H
	2606	Guia de rodamiento		2	L			

Ref.	Descripción	Horizontal		Vertical	
		Cantidad	Medida	Cantidad	Medida
31061	Junta elevable	8	L / 2	4	H
30710	Cepillo (7x9)			4	H

Ref.	Descripción	Cant.
30180	Escuadra ventana	16
30615	Escuadra alineamiento hoja	16
30465	Juego tapas cruce de hojas	2
30124	Cortavientos inferior	1
30125	Cortavientos superior	1
	Kit corredera elevable	2
30375	Tapa salida de aguas	4

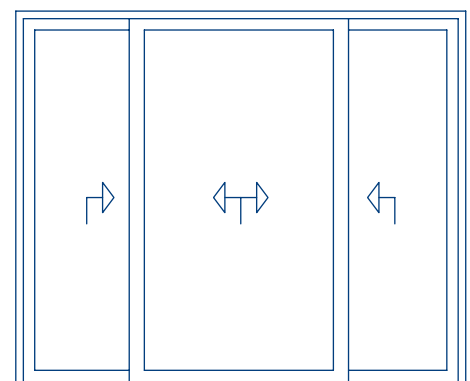



## Ventana 3 hojas iguales elevable 2 móviles + 1 fija (Apertura 1/3)

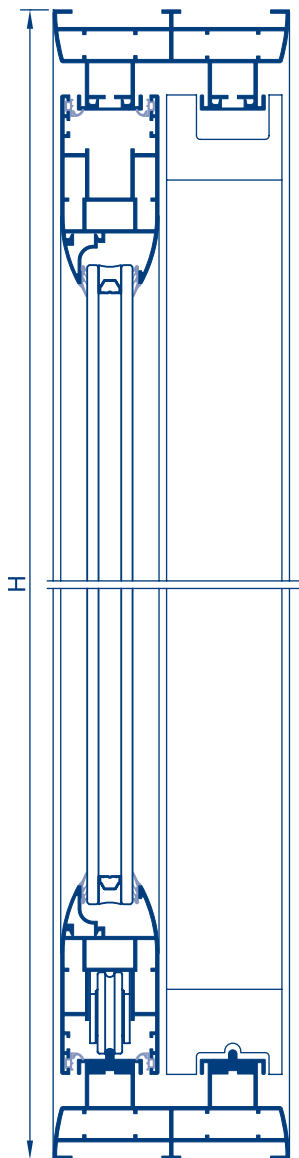
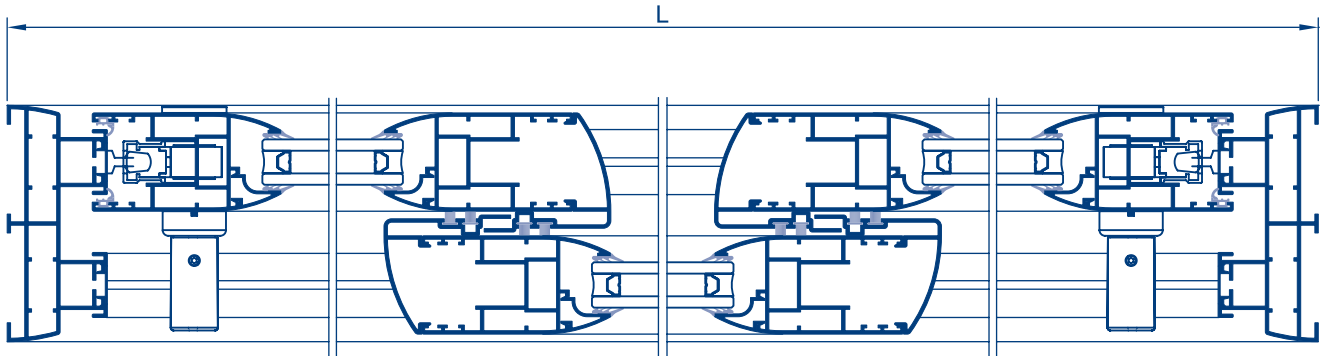

	Ref.	Descripción	Horizontal			Vertical		
			Corte	Cantidad	Medida	Corte	Cantidad	Medida
	2600	Marco perimetral		2	L		2	H
	2602	Hoja perimetral		4 2	L/3 - 23 L/3 + 23		6	H - 90
	2604	Cruce de hojas					4	H - 180
	2603	Junquillo clip					6	H - 237
	2609	Junquillo grapa		4	L/2 - 161			
	2605	Tapa marco		2	L		4	H
	2606	Guia de rodamiento		2	L			

Ref.	Descripción	Horizontal		Vertical	
		Cantidad	Medida	Cantidad	Medida
31061	Junta elevable	8	L / 2	4	H
30710	Cepillo (7x9)			4	H

Ref.	Descripción	Cant.
30180	Escuadra ventana	16
30615	Escuadra alineamiento hoja	16
30465	Juego tapas cruce de hojas	2
30124	Cortavientos inferior	1
30125	Cortavientos superior	1
	Kit corredera elevable	2
30375	Tapa salida de aguas	4

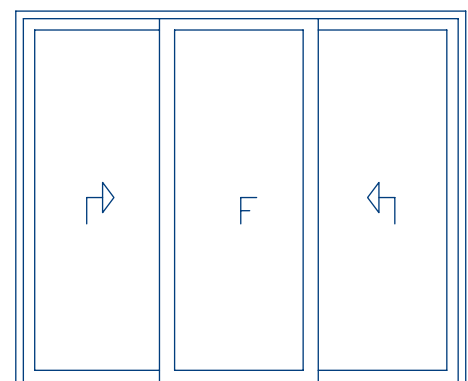



## Ventana 3 hojas desiguales elevable 2 móviles + 1 fija (Apertura 1/2)

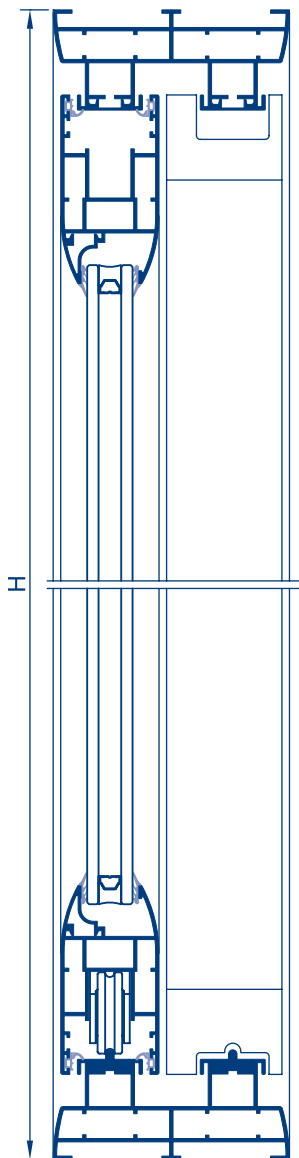
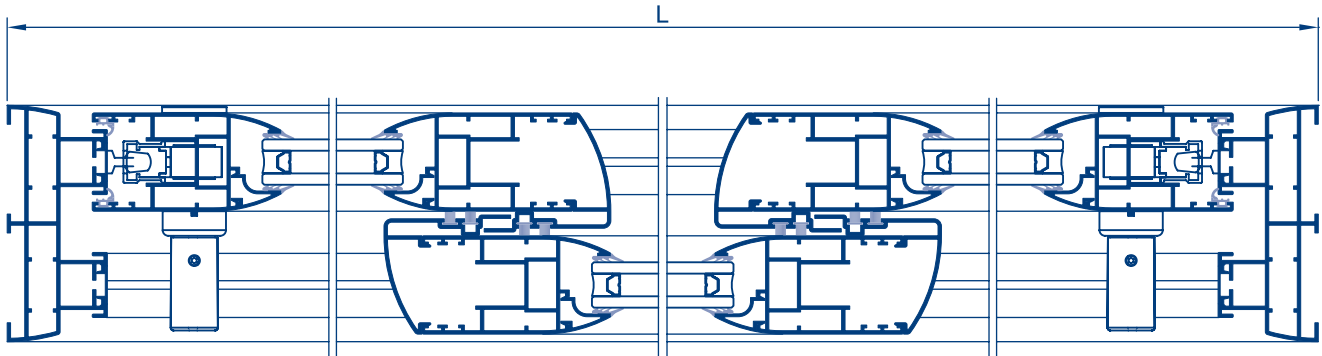

	Ref.	Descripción	Horizontal			Vertical		
			Corte	Cantidad	Medida	Corte	Cantidad	Medida
	2600	Marco perimetral		2	L		2	H
	2602	Hoja perimetral		4 2	L/4 + 56 L/2 - 43		4	H - 90
	2604	Cruce de hojas					4	H - 180
	2603	Junquillo clip					4	H - 237
	2609	Junquillo grapa		4	L/2 - 161			
	2605	Tapa marco		2	L		4	H
	2606	Guia de rodamiento		2	L			

Ref.	Descripción	Horizontal		Vertical	
		Cantidad	Medida	Cantidad	Medida
31061	Junta elevable	8	L / 2	4	H
30710	Cepillo (7x9)			4	H

Ref.	Descripción	Cant.
30180	Escuadra ventana	16
30615	Escuadra alineamiento hoja	16
30465	Juego tapas cruce de hojas	2
30124	Cortavientos inferior	1
30125	Cortavientos superior	1
	Kit corredera elevable	2
30375	Tapa salida de aguas	4

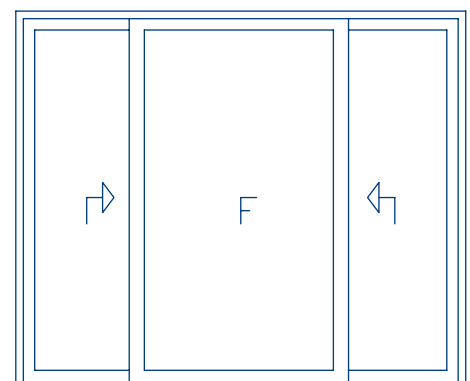



**Ref.  
30615**

Escuadra alineación  
25x8.5x1.2

50uds / bolsa

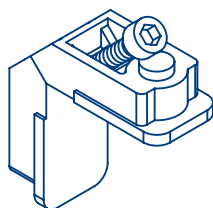

**Ref.  
30180**

Escuadra de  
tetón  
24x14



250uds / caja



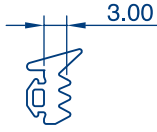
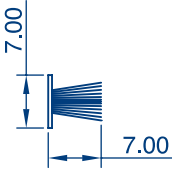
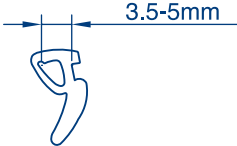
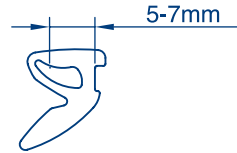
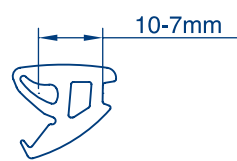



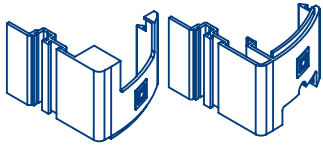
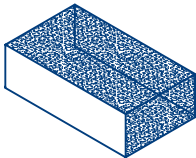
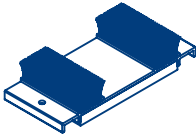
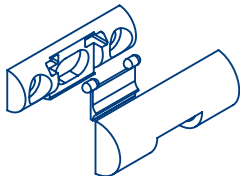

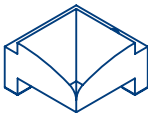

 <p><b>Ref. 31061</b> Junta elevable</p> <p>200 m / caja</p>	 <p><b>Ref. 31072</b> Junta ext. acristalar 3.5x3.0</p> <p>200 m / caja</p>
 <p><b>Ref. 30709</b> Cepillo 7x7</p> <p>2 rollos / caja 450 m / rollo</p>	 <p><b>Ref. 31073</b> Junta int. acristalar 3.5-5mm</p> <p>200 m / caja</p>
	 <p><b>Ref. 31074</b> Junta int. acristalar 5-7mm</p> <p>150 m / caja</p>
	 <p><b>Ref. 31075</b> Junta int. acristalar 7-10mm</p> <p>100 m / caja</p>

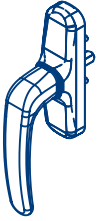
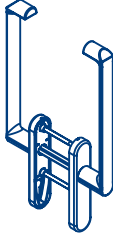
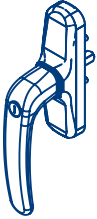
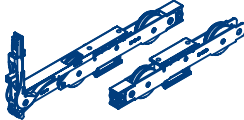

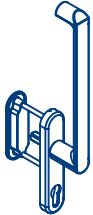
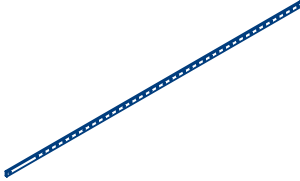
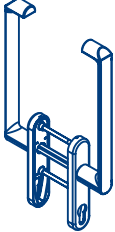
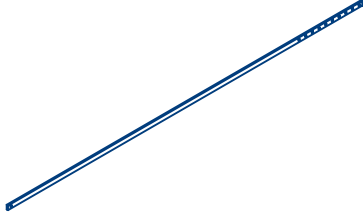
 x ud	<b>Ref. 30465</b> Juego tapas cruce de hojas Domo 125	
 x ud	<b>Ref. 30125</b> Cortavientos superior Domo 125	
 x ud	<b>Ref. 30124</b> Cortavientos inferior Domo 125	
 x ud	<b>Ref. 30375</b> Desagüe con válvula negra	
 200uds / bolsa	<b>Ref. 30645</b> Grapa de ajunquillar	
 100uds / bolsa	<b>Ref. 30311</b> Esquinero para junquillo curvo CR/BL/NE	

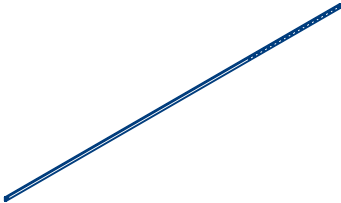

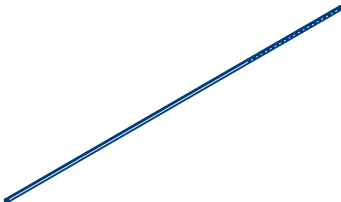

	<p><b>Ref. 32154**</b> Manilla practicable BL/CR/LC/NE/LP/LI</p>		<p><b>Ref. 32755**</b> Manilla ESURI int/ext BL/CR/LC/NE/LP/LI Domo 125 / 125RT</p>
	<p><b>Ref. 32155**</b> Manilla practicable con llave BL/CR/LC/NE/LP/LI</p>		<p><b>Ref. 32700SA</b> Kit carros corredera elevable Domo 125 / 125RT</p>
	<p><b>Ref. 32750**</b> Manilla ESURI + uñero BL/CR/LC/NE/LP/LI Domo 125 / 125RT</p>		<p><b>Ref. 32701SA</b> Kit carros intermedios corredera elevable Domo 125 / 125RT</p>
	<p><b>Ref. 32751**</b> Manilla ESURI c/llave + uñero BL/CR/LC/NE/LP/LI Domo 125 / 125RT</p>		<p><b>Ref. 32705SA</b> Pletina unión carros 1 L=1100 Domo 125RT</p>
	<p><b>Ref. 32752**</b> Manilla ESURI int/ext c/llave BL/CR/LC/NE/LP/LI Domo 125 / 125RT</p>		<p><b>Ref. 32706SA</b> Pletina unión carros 2 L=1340 Domo 125RT</p>
	<p><b>Ref. 32753**</b> Manilla ESURI + roseta BL/CR/LC/NE/LP/LI Domo 125 / 125RT</p>		<p><b>Ref. 32707SA</b> Pletina unión carros 3 L=1790 Domo 125RT</p>
	<p><b>Ref. 32754**</b> Manilla ESURI c/llave + roseta BL/CR/LC/NE/LP/LI Domo 125 / 125RT</p>		<p><b>Ref. 32708SA</b> Pletina unión carros 4 L=2790 Domo 125RT</p>

Para pedidos en bicolor, especificar colores interior exterior en los herrajes que corresponda.

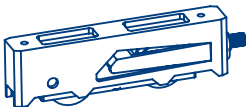
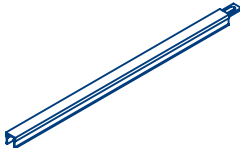
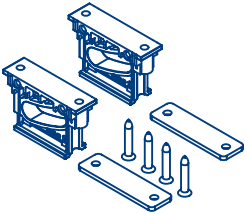
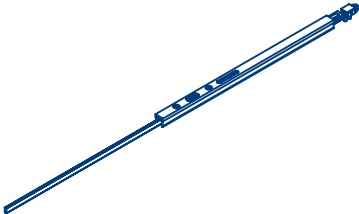
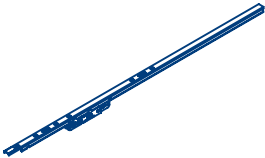
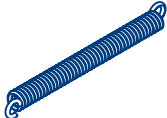
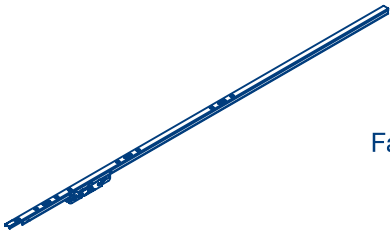
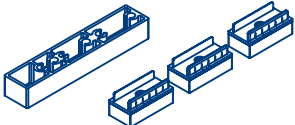
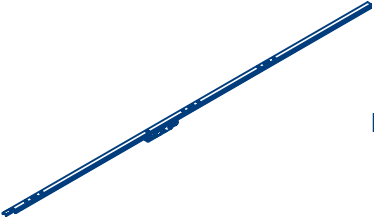
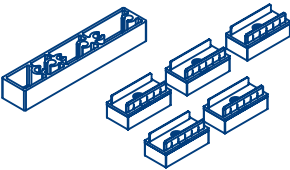
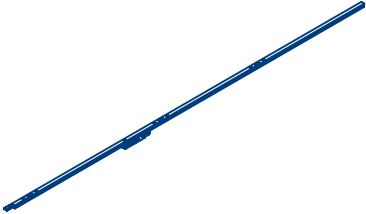
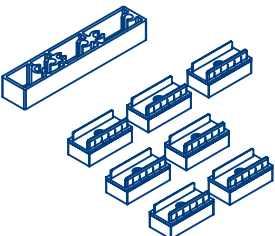
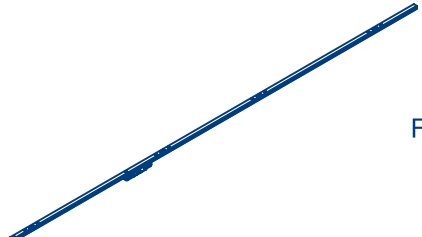
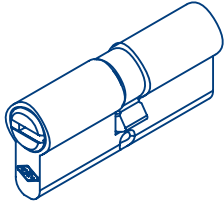

 <p><b>Ref. 30670</b> Ruleta tandem regulable en línea Domo 125/125R</p>	 <p><b>Ref. 32715SA</b> Prolongador de falleba sin cerradero. Domo 125RT</p>
 <p><b>Ref. 32703SA</b> Kit 2 suplementos hoja fija Domo 125/125R</p>	 <p><b>Ref. 32716SA</b> Prolongador de falleba con cerradero. Domo 125RT</p>
 <p><b>Ref. 32711SA</b> Falleba 1 elevable L=1190 Domo 125RT</p>	 <p><b>Ref. 32704SA</b> Muelle auxiliar</p>
 <p><b>Ref. 32712SA</b> Falleba 2 elevable L=1770 Domo 125RT</p>	 <p><b>Ref. 32717SA</b> Kit suplementos 16mm Falleba 1 Domo 125RT</p>
 <p><b>Ref. 32713SA</b> Falleba 3 elevable L=2270 Domo 125RT</p>	 <p><b>Ref. 32718SA</b> Kit suplementos 16mm Falleba 2,3,4 Domo 125RT</p>
 <p><b>Ref. 32714SA</b> Falleba 4 elevable L=2670 Domo 125RT</p>	 <p><b>Ref. 32726SA</b> Kit suplementos 16mm Falleba 5 Domo 125RT</p>
 <p><b>Ref. 32725SA</b> Falleba 5 elevable L=3170 Domo 125RT</p>	 <p><b>Ref. 32119SA</b> Cilindro seguridad 72mm leva larga 30-30</p>

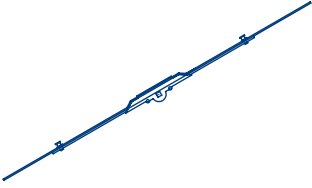
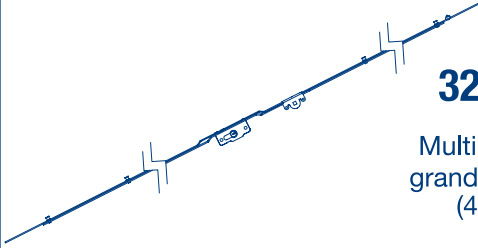
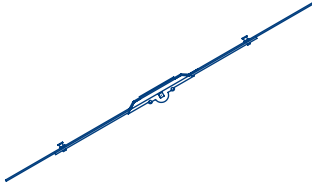
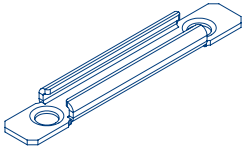
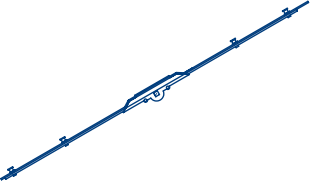
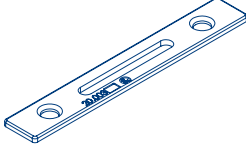
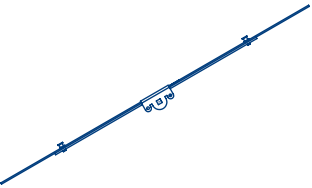

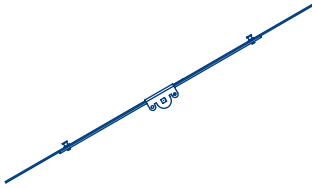
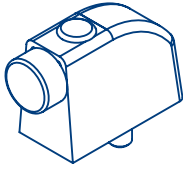
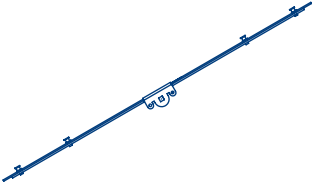
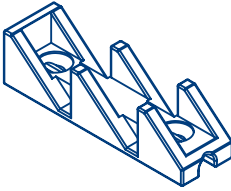
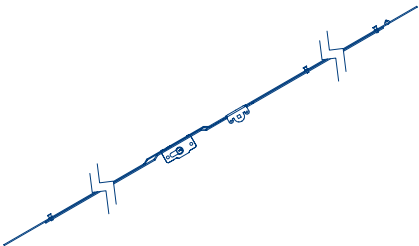
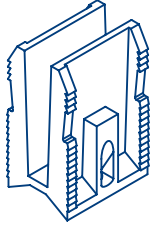
	<p><b>Ref. 32730SA</b></p> <p>Multipunto 600 pequeño 7.5 (2 puntos)</p>		<p><b>Ref. 32737SA</b></p> <p>Multipunto 1800 grande 15 c/llave (4 puntos)</p>
	<p><b>Ref. 32731SA</b></p> <p>Multipunto 1000 mediano 7.5 (2 puntos)</p>		<p><b>Ref. 32740SA</b></p> <p>Cerradero</p>
	<p><b>Ref. 32732SA</b></p> <p>Multipunto 1600 grande 7.5 (4 puntos)</p>		<p><b>Ref. 32742SA</b></p> <p>Calzo cerradero</p>
	<p><b>Ref. 32733SA</b></p> <p>Multipunto 600 pequeño 15 (2 puntos)</p>		<p><b>Ref. 32710SA</b></p> <p>Bulón cierre elevable Domo 125RT</p>
	<p><b>Ref. 32734SA</b></p> <p>Multipunto 1000 mediano 15 (2 puntos)</p>		<p><b>Ref. 32720SA</b></p> <p>Tope 90° negro Domo 125RT</p>
	<p><b>Ref. 32735SA</b></p> <p>Multipunto 1600 grande 15 (4 puntos)</p>		<p><b>Ref. 32719SA</b></p> <p>Delimitador ventilación elevable Domo 125RT</p>
	<p><b>Ref. 32736SA</b></p> <p>Multipunto 1600 grande 15 c/llave (3 puntos)</p>		<p><b>Ref. 32709SA</b></p> <p>Guía pletina unión carros elevable Domo 125RT</p>



## Esquemas de apertura de correderas



## Herraje corredera en línea 125RT

Ref.		Descripción	Esquemas de apertura					
			A	B	C	D		
30124		Cortavientos sup./inf.	1	1	2	2		
30465		Juego tapas cruce	2	2	4	4		
30670		Ruleta tandem regulable (Hasta 160kg/ud)	2	4	4	6		
32703SA		Kit suplementos hoja fija	1		1			
Multipunto	Pequeño	32733SA	Multipunto pequeño 15 (600mm 2 Ptos)	1	2	2	2	
		32740SA	Cerradero	2	4	4	4	
		32742SA	Calzo cerraderos	2	4	4	4	
	Mediano	32734SA	Multipunto mediano 15 (1000mm 2 Ptos)	1	2	2	2	
		32740SA	Cerradero	2	4	4	4	
		32742SA	Calzo cerraderos	2	4	4	4	
	Grande	32735SA	Multipunto grande 15 (1600mm 4 Ptos)	1	2	2	2	
		32740SA	Cerradero	4	8	8	8	
		32742SA	Calzo cerraderos	4	8	8	8	
	1600 c/ll	32736SA	Multipunto 1600 grande c/llave 15 (3 Ptos)	1	2	2	2	
		32740SA	Cerradero	3	6	6	6	
		32742SA	Calzo cerraderos	3	6	6	6	
		32119SA	Cilindro seguridad 72mm leva larga 25-35	1	2	2	2	
		1800 c/ll	32737SA	Multipunto 1800 grande c/llave 15 (4 Ptos)	1	2	2	2
			32740SA	Cerradero	4	8	8	8
32742SA	Calzo cerraderos		4	8	8	8		
32119SA		Cilindro seguridad 72mm leva larga 25-35	1	2	2	2		
32154**		Manilla practicable	1	2	2	2		
32155**		Manilla practicable c/llave						

Para pedidos en bicolor, especificar colores interior exterior en los herrajes que corresponda.



## Herrajes para Elevables Domo 125

		Ancho hojas	700-1600			1601-1850			1851-2350			2351-3300			
		Nº de hojas	1H	2H	3H	1H	2H	3H	1H	2H	3H	1H	2H	3H	
Ref.	Descripción	Alto de hoja													
32700SA	Kit carros corredera elevable 300kg	<300 kg	1	2	3	1	2	3	1	2	3	1	2	3	
32701SA	Kit carros intermedios elevable 400kg	<400 kg	1	2	3	1	2	3	1	2	3	1	2	3	
32705SA	Pletina unión carros 1 (HS-20) 1100mm	750-3200	1	2	3										
32706SA	Pletina unión carros 2 (HS-21) 1340mm					1	2	3							
32707SA	Pletina unión carros 3 (HS-22) 1790mm								1	2	3				
32708SA	Pletina unión carros 4 (HS-23) 2790mm											1	2	3	
32709SA	Guía pletina unión carros			1	2	3	1	2	3	1	2	3	1	2	3
32711SA	Falleba 1 Elevable plata L=1190 Dm400	750-1300													
32712SA	Falleba 2 Elevable plata L=1770 Dm400	1301-1880													
32713SA	Falleba 3 Elevable plata L=2270 Dm1000	1881-2380	1	2	3	1	2	3	1	2	3	1	2	3	
32714SA	Falleba 4 Elevable plata L=2670 Dm1000	2381-2780													
32725SA	Falleba 5 Elevable plata L=3170 Dm1000	2781-3200													
32704SA	Muelle auxiliar	>150 kg	1	2	3	1	2	3	1	2	3	1	2	3	
32717SA	Kit suplemento 16.0mm falleba Tipo 1	750-3200													
32718SA	Kit suplemento 16.0mm falleba tipo 2,3,4		1	2	3	1	2	3	1	2	3	1	2	3	
32726SA	Kit suplemento 16.0mm falleba tipo 5														
32710SA	Bulón cierre 1 elevable (HS-062) alto=27mm		2	4	4	2	4	4	2	4	4	2	4	4	
32719SA	Delimitador ventilación elevable (HS-066)		1	2	2	1	2	2	1	2	2	1	2	2	
32720SA	Tope corredera elevable (HS-067)		1	2	2	1	2	2	1	2	2	1	2	2	
32750xx	Manilla int. + uñero														
32751xx	Manilla int. c/llave + uñero														
32752xx	Manilla int./ext. c/llave														
32753xx	Manilla int. + roseta		1	2	3	1	2	3	1	2	3	1	2	3	
32754xx	Manilla int. c/llave + roseta														
32755xx	Manilla int. / ext.														
32703SA	Kit suplementos hoja fija	<300 kg	1 Kit por hoja fija												

Para pedidos en bicolor, especificar colores interior exterior en los herrajes que corresponda.



## Domo 125RT - 125

Ref.- 60025

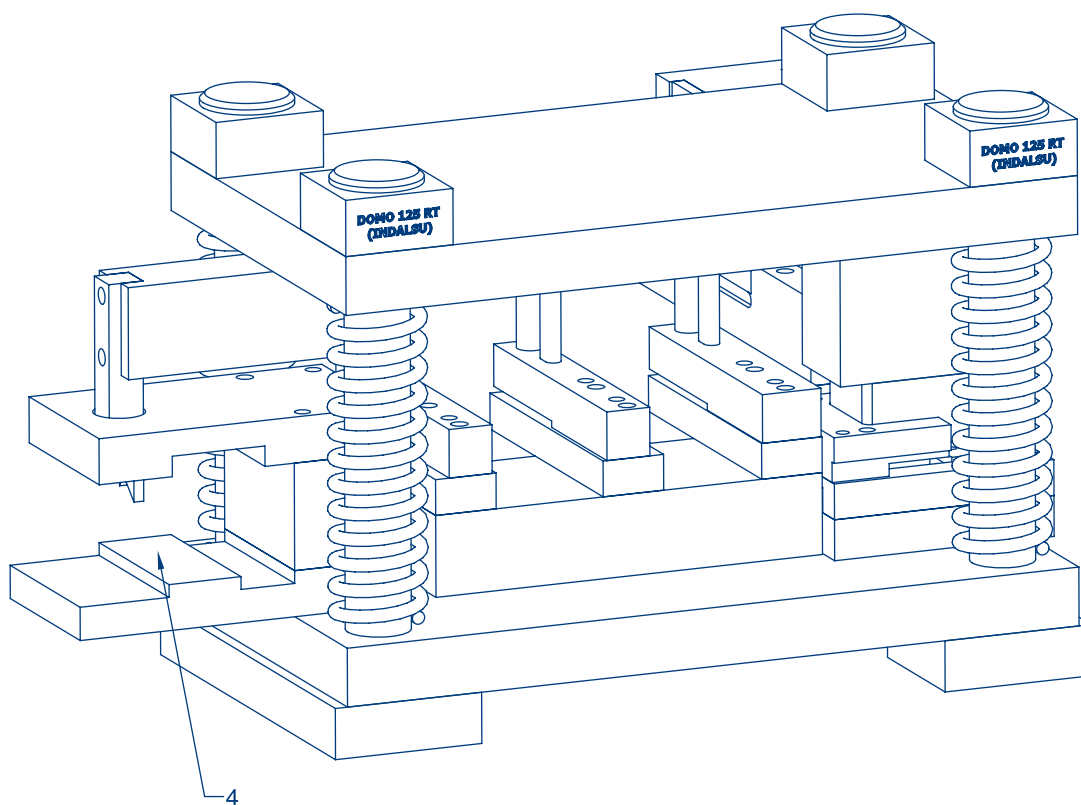
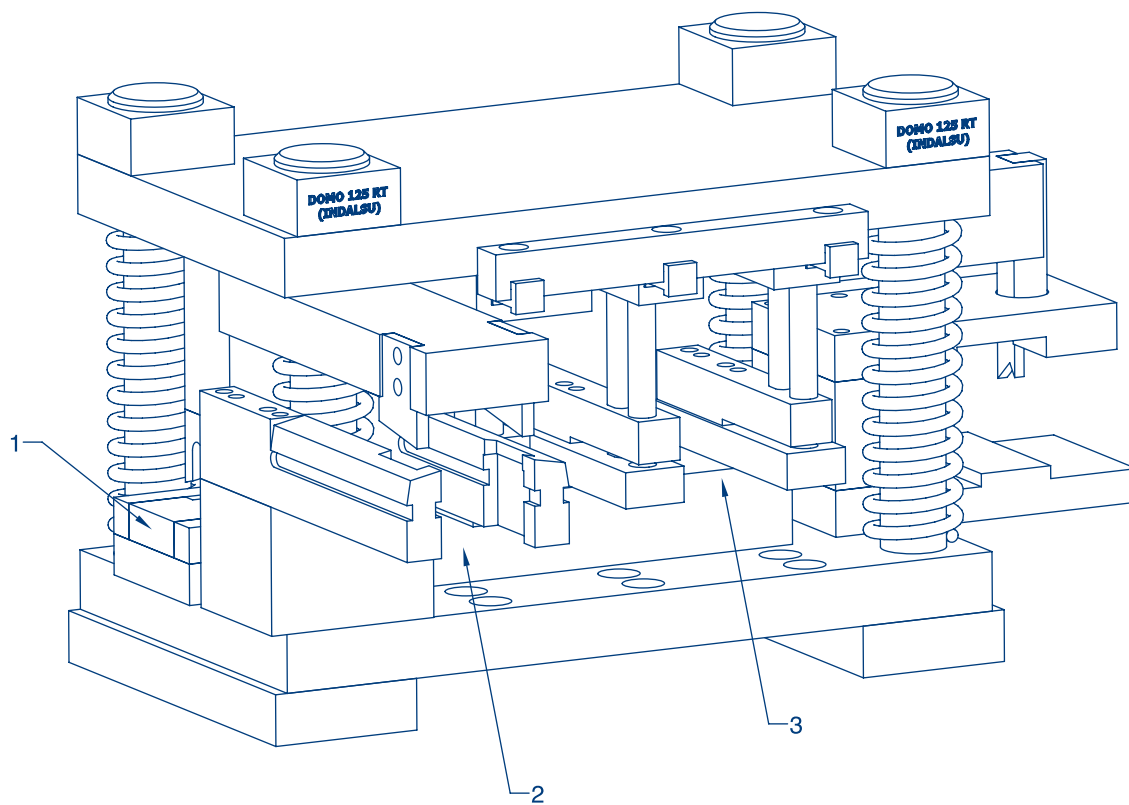





1.- Mecanizado tapeta.  
Solo de uso en la Domo 125RT

2.- Mecanizado salida de aguas a tubular.

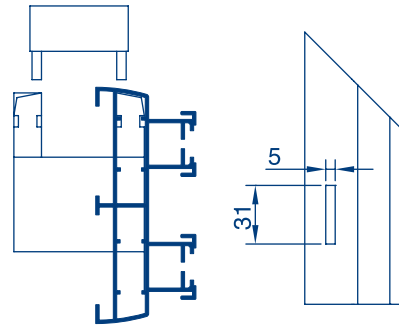

3.- Mecanizado escuadras de marco.

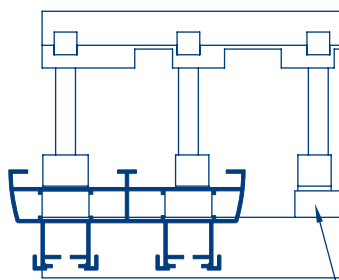

Solo para  
Domo 125RT

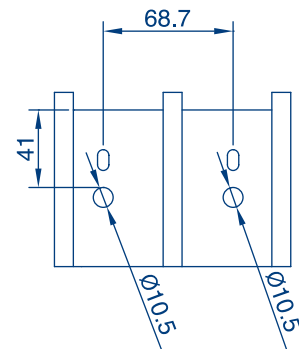

Nota: El marco tricarril se realiza en troquel manual 60030.

3.- Mecanizado escuadra de hoja.

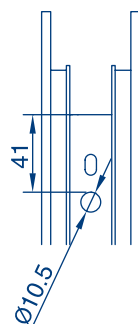
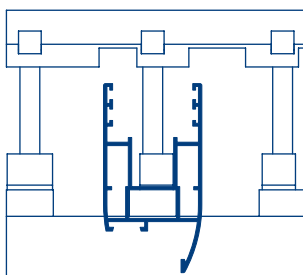

4.- Mecanizado salida de aguas indirecta.

