

SERIE C71C

CARACTERÍSTICAS GENERALES

- Ancho de marco: 71 mm.
- Ancho de hoja: 28 mm.
- Serie fría.
- Acristalamiento máximo: 18 mm.
- Espesor general: 1,5 mm.
- Unión a testa e inglete (marco y hoja)
- Peso máximo por hoja: 100 Kg.

POSIBILIDADES CONSTRUCTIVAS

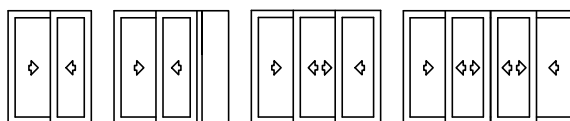

PRESTACIONES

- Permeabilidad al aire: **Clase 3** (UNE-EN 12207:2000)
- Estanquidad al agua: **Clase 7A** (UNE-EN 12208:2000)
- Resistencia al viento: **Clase C5** (UNE-EN 12210:2000)

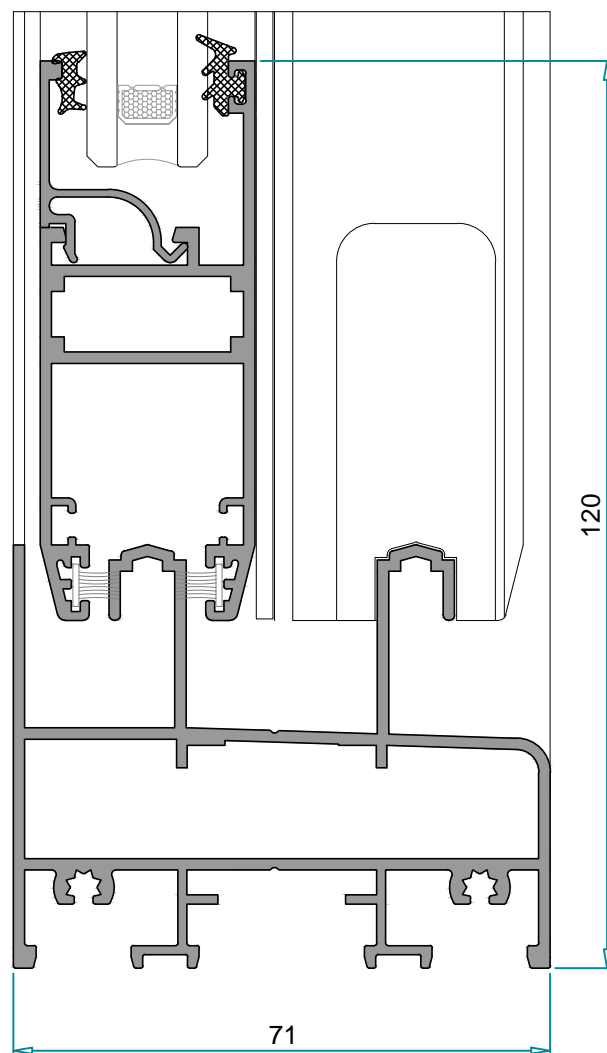

Certificado de Ensayos



CIDEMCO
CENTRO DE INVESTIGACION TECNOLÓGICA

Pol. Ind. Lasao, Area Anardi, nº 5
20730 AZPEITIA (Guipúzcoa)
Tel.: 943 816800 – Fax: 943 816074
Email: cidemco@cidemco.es
http://www.cidemco.es

ORGANISMO
NOTIFICADO

nº 1239

EMPRESA	SAPA PROFILES ESPAÑA S.L.
DIRECCIÓN	CTRA. N-400 km 55,5 TOLEDO-CUENCA 45350 NOBLEJAS (TOLEDO)
Nº CERTIFICADO	18130

**VENTANA DE ALUMINIO (1.200 x 1.215) mm
CORREDERA DOS HOJAS
REF. «AR FUSION C71C»**

ENSAYO	RESULTADO
PERMEABILIDAD AL AIRE (UNE-EN 1026:2000)	CLASE 3
ESTANQUIDAD AL AGUA (UNE-EN 1027:2000)	CLASE 7A
RESISTENCIA A LA CARGA DE VIENTO (UNE-EN 12211:2000)	CLASE C5

FECHA 21 de febrero de 2008

Este documento no tiene validez sin el informe de ensayos, en el cual se indican los resultados obtenidos en cada ensayo.

Los resultados obtenidos en estos ensayos solo se refieren a la(s) muestra(s) analizada(s) en este Centro en la fecha indicada y no implican una característica de constancia en la calidad de la producción



Fdo: **Asier Maiztegui**
Director Dpto. Construcción

MARCOS

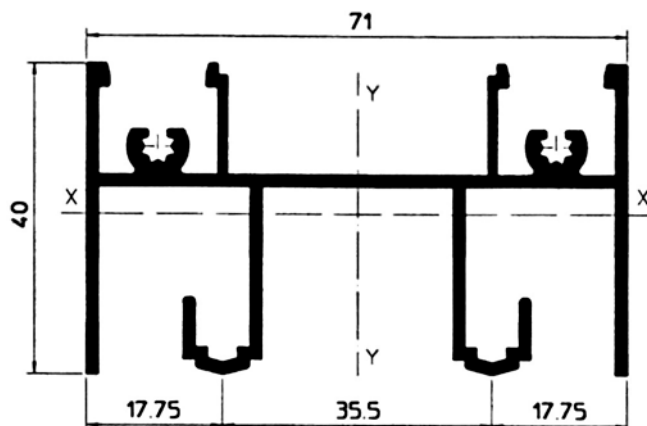

63379 MARCO SUPERIOR

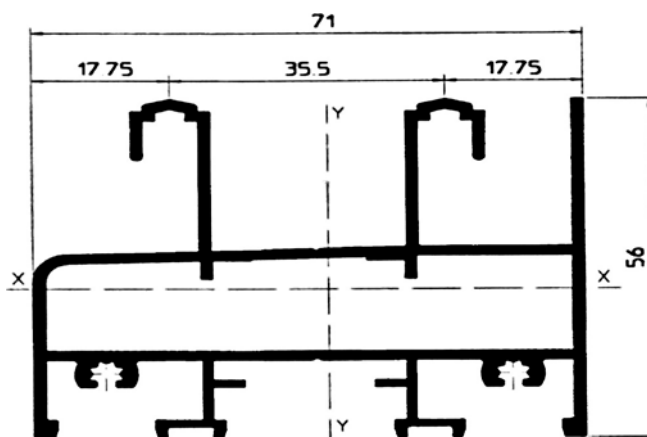

63591 MARCO INFERIOR C/CAMARA

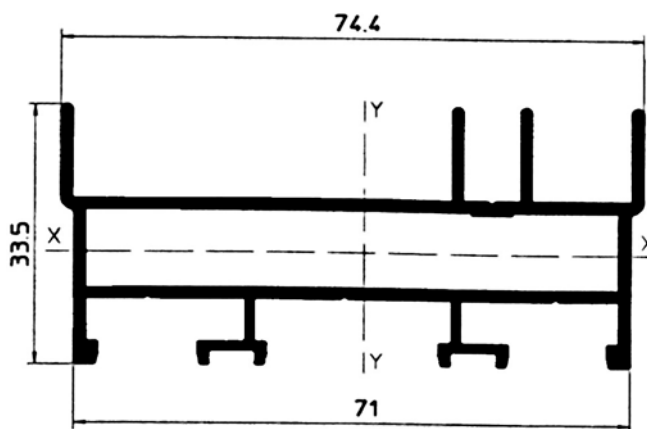

63807 MARCO LATERAL C/CAMARA

MARCOS

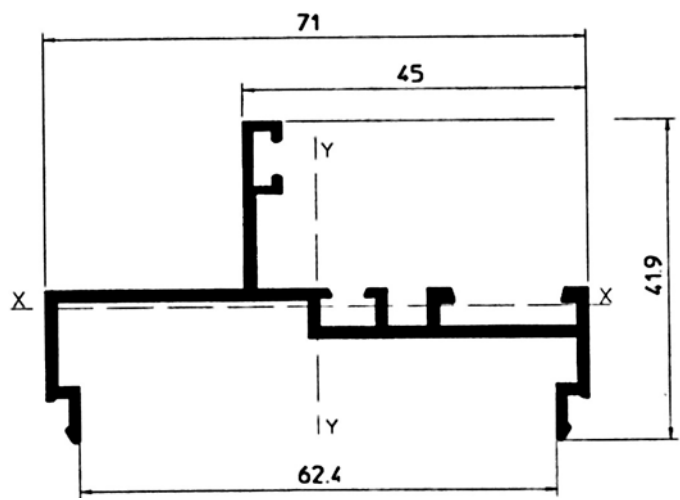

63380 MARCO FIJO LATERAL CLIPAR

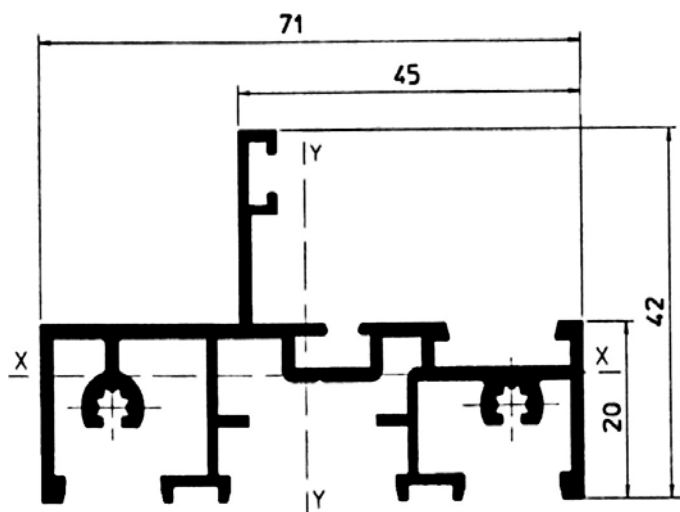

63381 MARCO FIJO SUP-INF. PORTATORNILLO

HOJAS

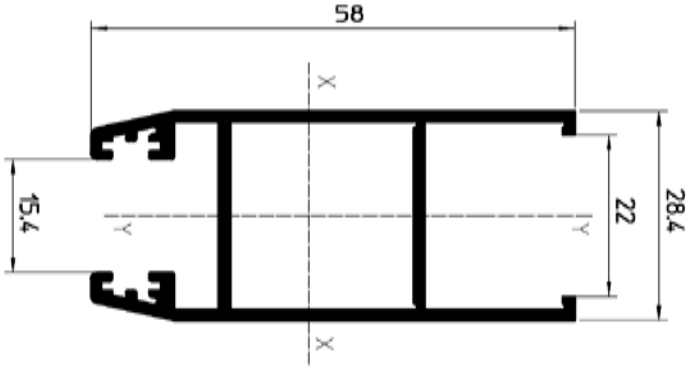

63373 HOJA LATERAL CLIMALIT

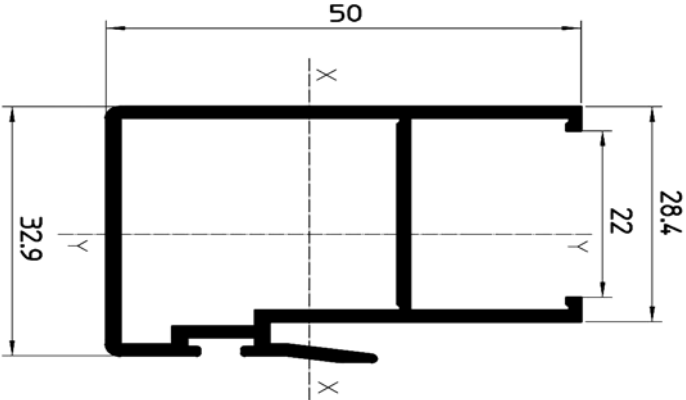

63374 HOJA CENTRO CLIMALIT

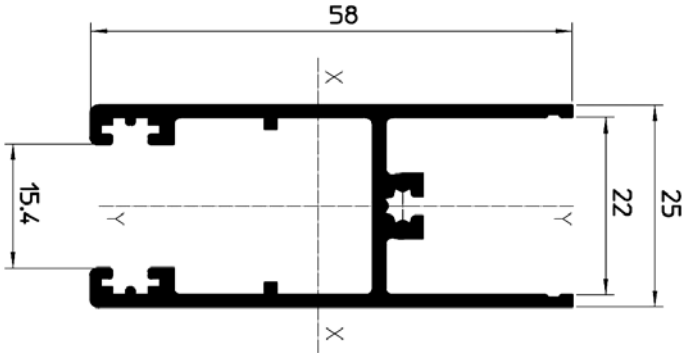

63375 HOJA RULETA CLIMALIT

HOJAS

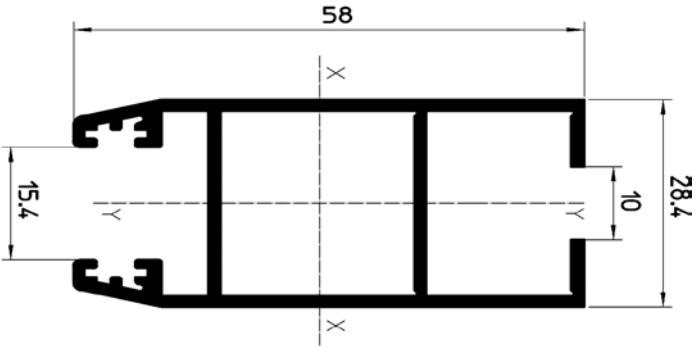

63410 HOJA LATERAL CRISTAL NORMAL

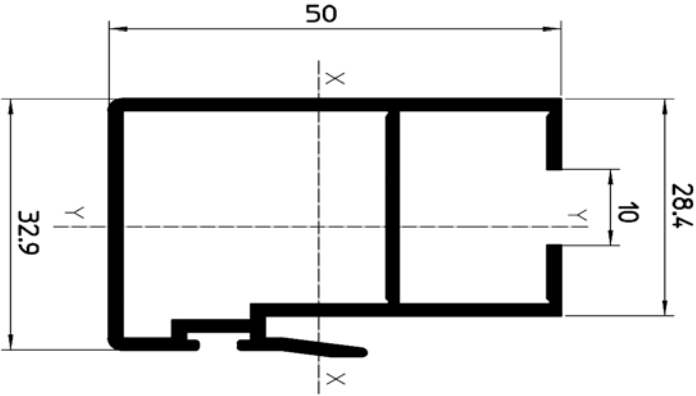

63411 HOJA CENTRO CRISTAL NORMAL

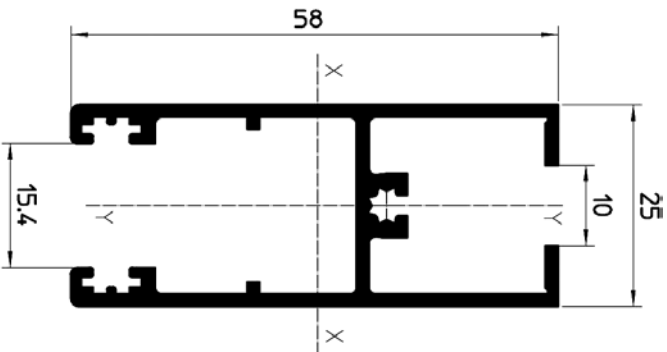

63412 HOJA RULETA CRISTAL NORMAL

CONDENSACIONES

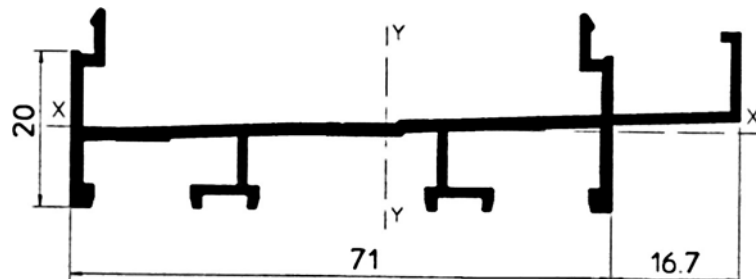

65104 CONDENSACION MAINEL

UNIONES - ESQUINEROS

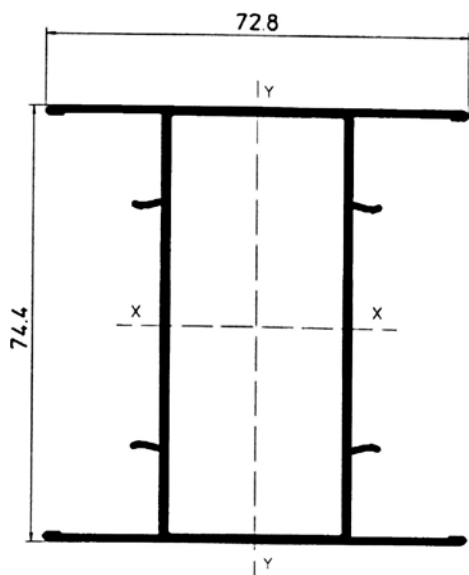

65103

UNION DE MARCOS TUBULAR

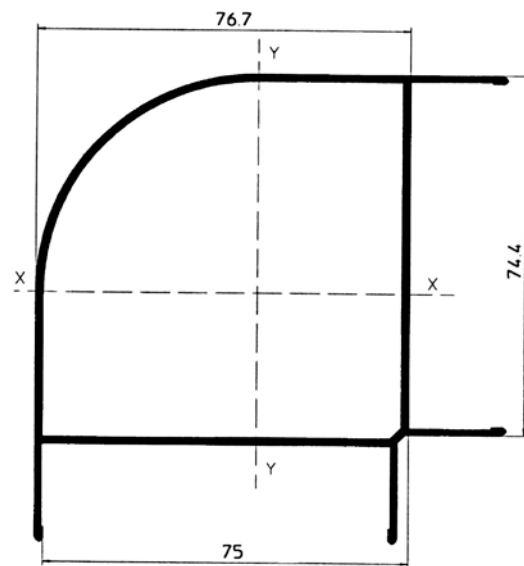

65105

ESQUINERO REDONDO 90°

ESPECIALES

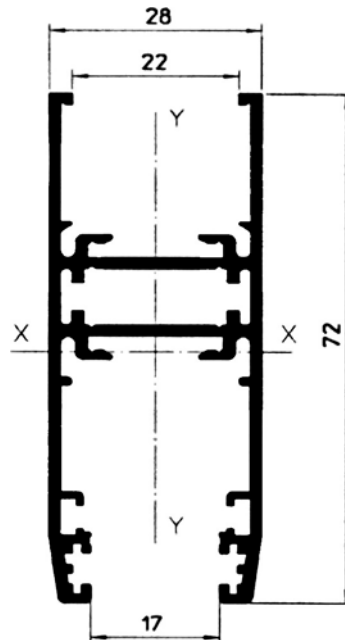

66602 HOJA LATERAL ESPECIAL

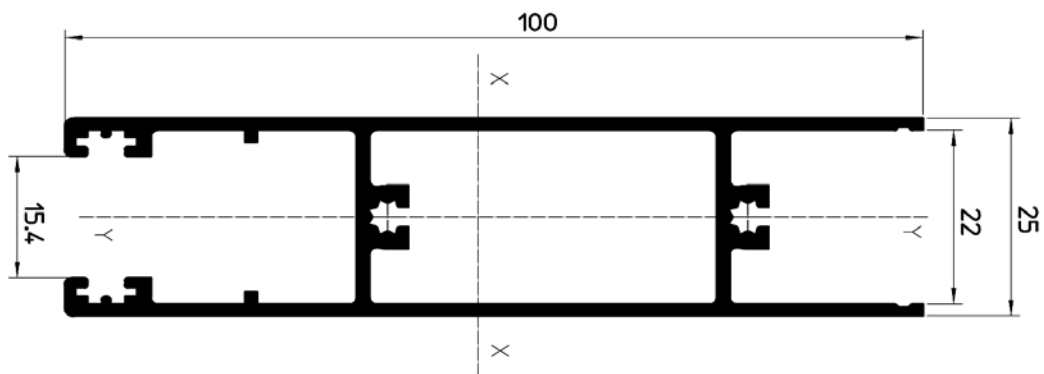

63413 ZOCALO CLIMALIT

ESPECIALES

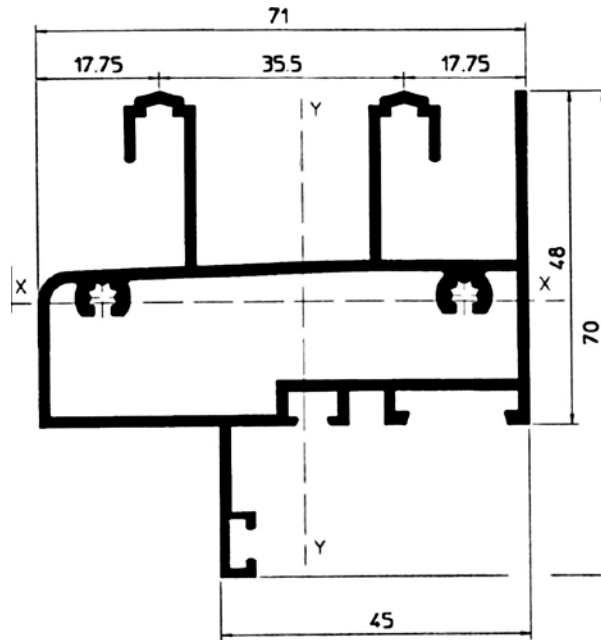

63382

MARCO SUPERIOR-INFERIOR C/FIJO

VARIOS

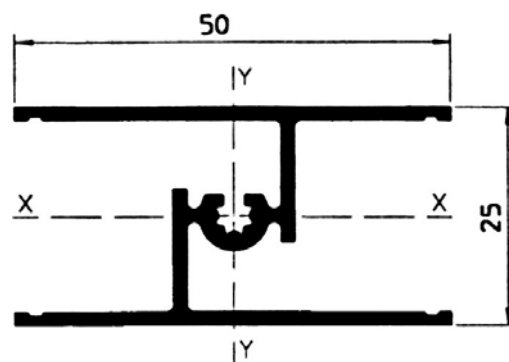

63414 HOJA DIVISION CLIMALIT

VARIOS

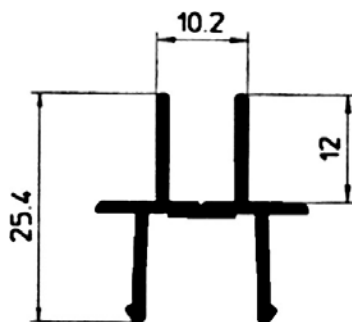

63780 ENCUENTRO 4 HOJAS

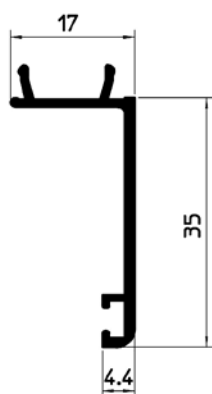

64616 TAPAJUNTAS EXTERIOR 35mm

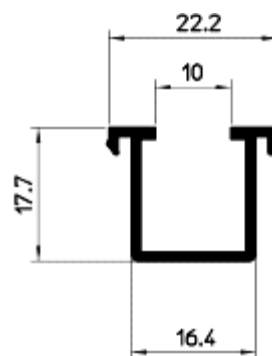

63415 REDUCTOR HOJAS A CRISTAL NORMAL

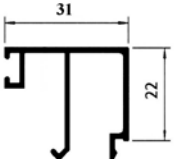
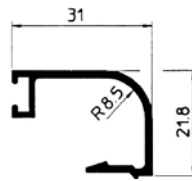
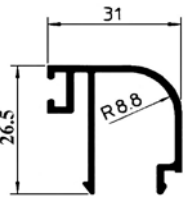
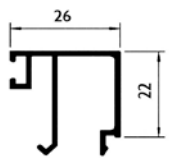
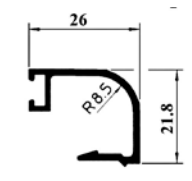
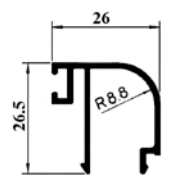
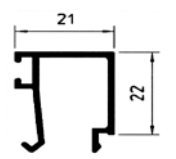
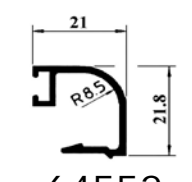
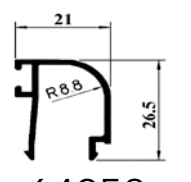
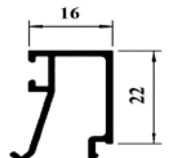
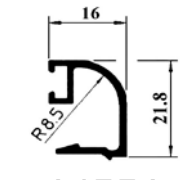
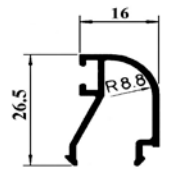
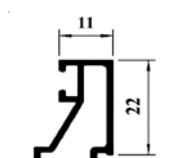
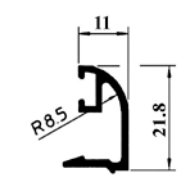
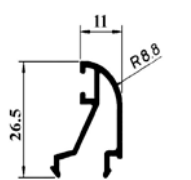
HUECOS CRISTAL EN MARCOS Y HOJAS CURVAS	REFERENCIA JUNQUILLOS		
9 mm	 <p>59849</p>	 <p>64554</p>	 <p>6011</p>
14 mm	 <p>58948</p>	 <p>64553</p>	 <p>64053</p>
19 mm	 <p>58949</p>	 <p>64552</p>	 <p>64052</p>
24 mm	 <p>59848</p>	 <p>64556</p>	 <p>64247</p>
29 mm	 <p>59847</p>	 <p>64557</p>	 <p>64248</p>

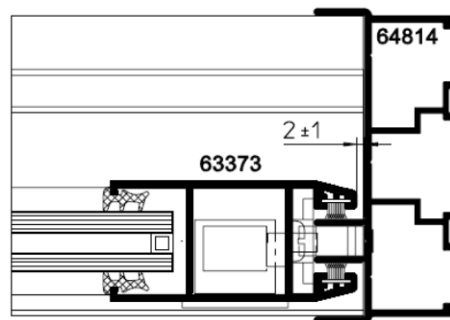
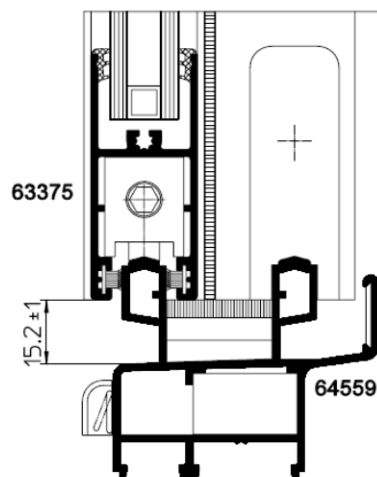
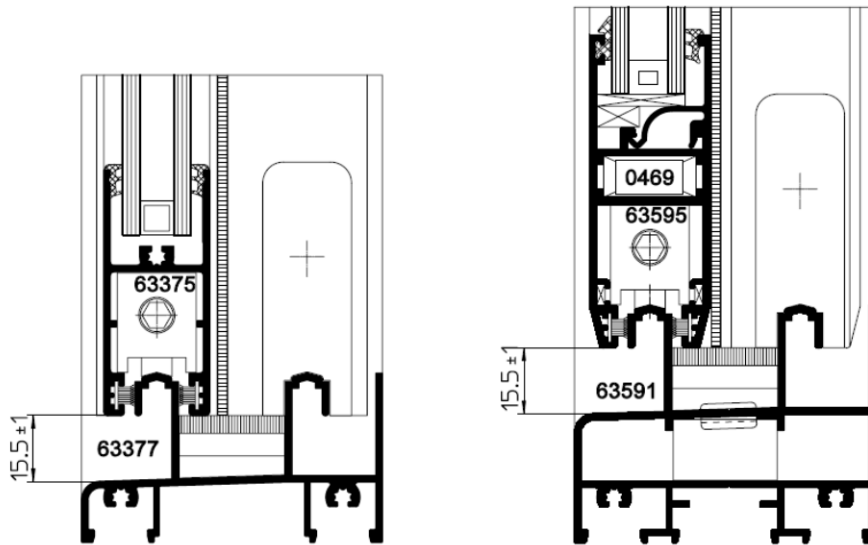

Detalle a escala reducida 2:3



sapa:

Los derechos de reproducción y propiedad de este plano pertenecen al Grupo Sapa y solamente pueden utilizarse o ceder a terceros con el consentimiento escrito del propietario.

C71C.III.01

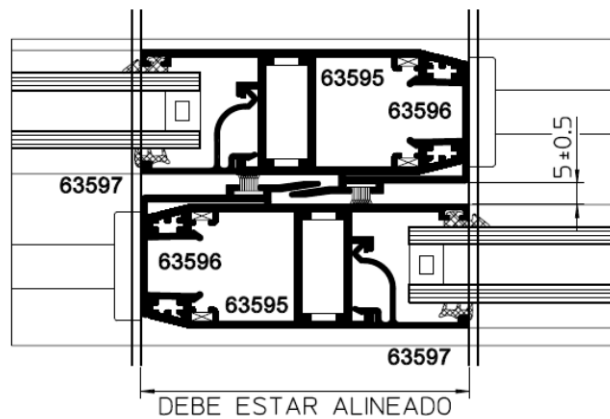
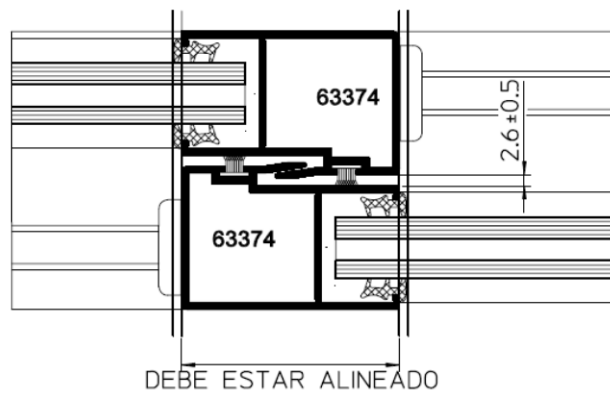
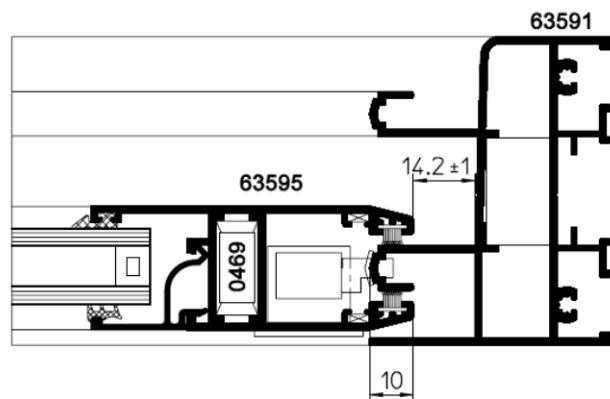
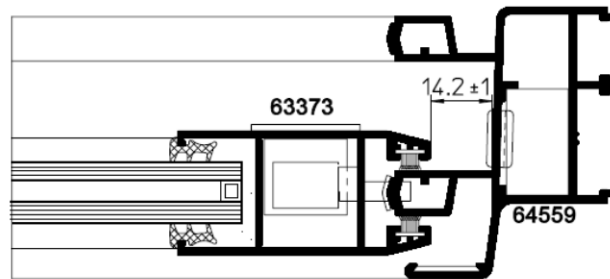

Detalle a escala reducida 2:3



sapa:

Los derechos de reproducción y propiedad de este plano pertenecen al Grupo Sapa y solamente pueden utilizarse o ceder a terceros con el consentimiento escrito del propietario.

C71C.III.02

Lista de corte

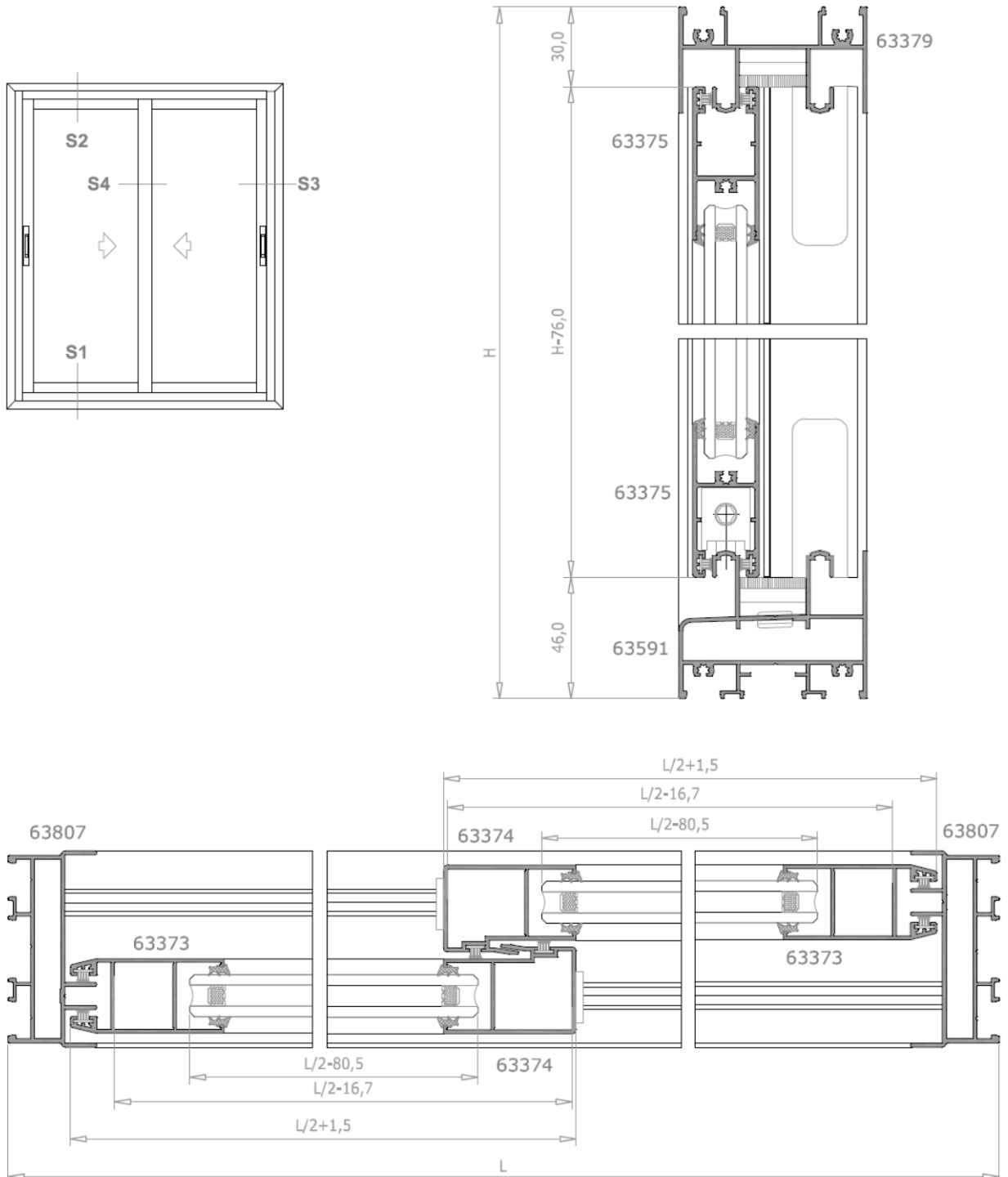

Lista de corte

Lista de corte de perfiles

Perfil	Denominación	Unidades	Corte
63807	Marco lateral.	2	H
63591	Marco inferior.	1	L-44
63379	Marco superior.	1	L-44
63375	Hoja ruleta.	4	L/2-16,7
63373	Hoja lateral	2	H-76
63374	Hoja central	2	H-76

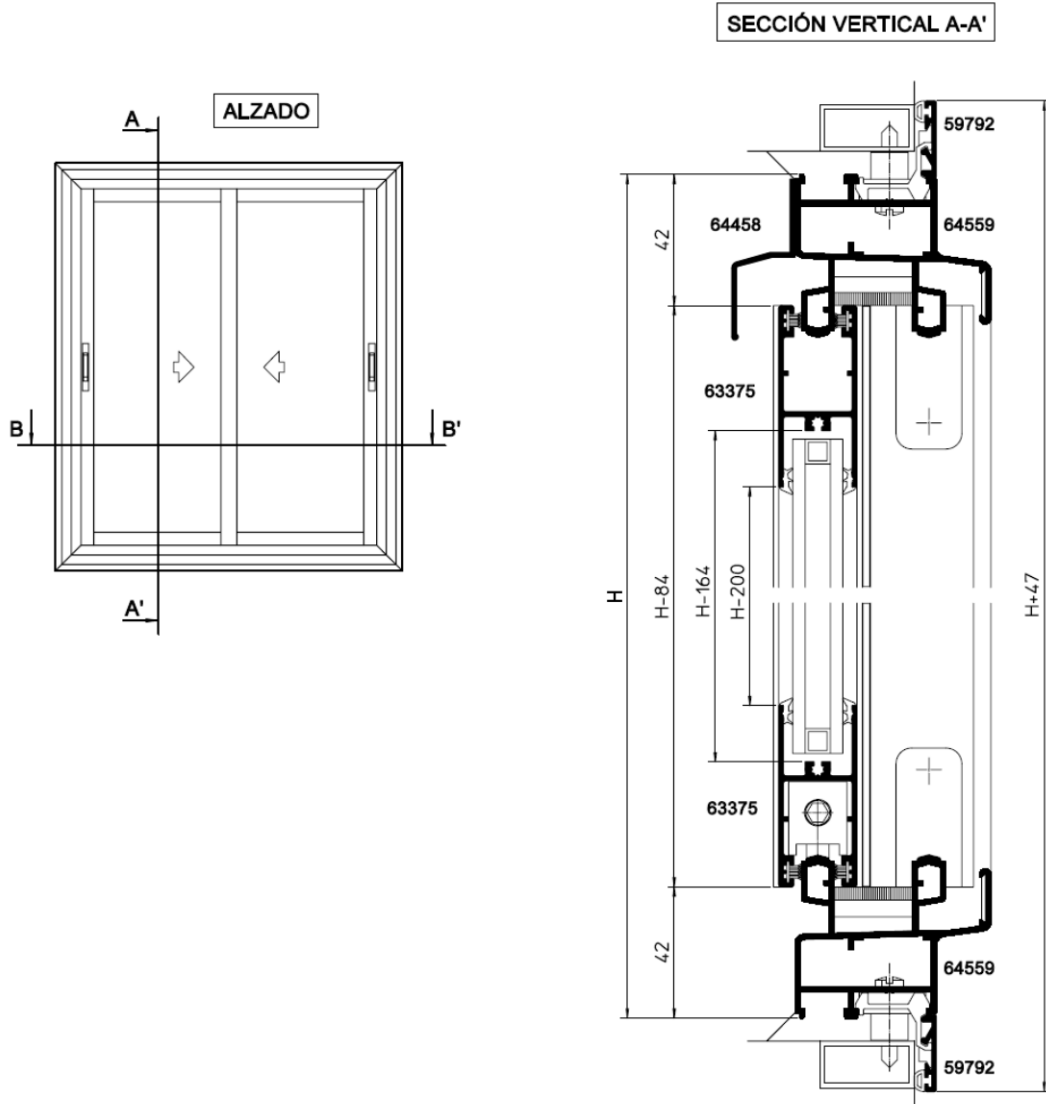

LISTA DE CORTE

PERFIL	DENOMINACION	UNIDADES	CORTE
59792	Tapajuntas (horizontal)	2	L+47
59792	Tapajuntas (vertical)	2	H+47
64559	Cerco horizontal	2	L
64559	Cerco vertical	2	H
63375	Hoja horizontal	4	L/2-35.2
63373	Hoja lateral	2	H-84
63374	Hoja central	2	H-84
64458	Vlerteaguas	1	L-3



sapa: